



MPC2000XL

MIDI PRODUCTION CENTER

AKAI
professional

Operator's Manual

WARNING

To prevent fire or shock hazard,
do not expose this appliance to
rain or moisture.

WARNING!!

To prevent fire or shock hazard, do not expose this appliance to rain or moisture.

1-En



CAUTION
RISK OF ELECTRIC SHOCK
DO NOT OPEN



CAUTION: TO REDUCE THE RISK OF ELECTRIC SHOCK
DO NOT REMOVE COVER (OR BACK).
NO USER-SERVICEABLE PARTS INSIDE.
REFER SERVICING TO QUALIFIED SERVICE PERSONNEL.

THE SYMBOLS ARE RULED BY UL STANDARDS (U.S.A.)



The lightning flash with arrowhead symbol, within an equilateral triangle, is intended to alert the user to the presence of uninsulated “dangerous voltage” within the product’s enclosure; that may be of sufficient magnitude to constitute a risk of electric shock to persons.



The exclamation point within an equilateral triangle is intended to alert the user to the presence of important operating and maintenance (servicing) instructions in the literature accompanying the appliance.

5B-En

WARNING: WHEN USING ELECTRIC PRODUCTS, BASIC PRECAUTIONS SHOULD ALWAYS BE FOLLOWED, INCLUDING THE FOLLOWING:

WARNING

The MPC2000XL is designed to be used in a standard household environment. Power requirements for electrical equipment vary from area to area. Please ensure that your MPC2000XL meets the power requirements in your area. If in doubt, consult a qualified electrician or AKAI professional dealer.

120 VAC @ 60 Hz for USA and Canada
220~240 VAC @ 50 Hz for Europe

PROTECTING YOURSELF AND THE MPC2000XL

- Never touch the AC plug with wet hands.
- Always disconnect the MPC2000XL from the power supply by pulling on the plug, not the cord.
- Allow only an AKAI professional dealer or qualified professional engineer to repair or reassemble the MPC2000XL. Apart from voiding the warranty, unauthorized engineers might touch live internal parts and receive a serious electrical shock. There are no serviceable parts inside.
- Do not put, or allow anyone to put any object, especially metal objects, into the MPC2000XL.
- Use only a household AC power supply. Never use a DC power supply.
- If water or any other liquid is spilled into or onto the MPC2000XL, disconnect the power, and call your dealer.
- Make sure that the unit is well-ventilated, and away from direct sunlight.
- To avoid damage to internal circuitry, as well as the external finish, keep the MPC2000XL away from sources of direct heat (stoves, radiators, etc.).
- Avoid using aerosol insecticides, etc. near the MPC2000XL. They may damage the surface, and may ignite.
- Do not use denaturated alcohol, thinner or similar chemicals to clean the MPC2000XL. They will damage the finish.
- Modification of this equipment is dangerous, and can result in the functions of the MPC2000XL being impaired. Never attempt to modify the equipment in any way.
- Make sure that the MPC2000XL is always well-supported when in use (either in a specially-designed equipment rack, or a firm level surface).
- In order to assure optimum performance of your MPC2000XL, select the setup location carefully, and make sure the equipment is used properly. Avoid setting up the MPC2000XL in the following locations:
 1. In a humid or dusty environment
 2. In a room with poor ventilation
 3. On a surface which is not horizontal
 4. Inside a vehicle such as a car, where it will be subject to vibration
 5. In an extremely hot or cold environment

WARNING
THIS APPARATUS MUST BE EARTHED
IMPORTANT

This equipment is fitted with an approved non-rewireable UK mains plug.
To change the fuse in this type of plug proceed as follows:

- 1) Remove the fuse cover and old fuse.
- 2) Fit a new fuse which should be a BS1362 5 Amp A.S.T.A or BSI approved type.
- 3) Refit the fuse cover.

If the AC mains plug fitted to the lead supplied with this equipment is not suitable for your type of AC outlet sockets, it should be changed to an AC mains lead, complete with moulded plug, to the appropriate type. If this is not possible, the plug should be cut off and a correct one fitted to suit the AC outlet. This should be fused at 5 Amps.

If a plug without a fuse is used, the fuse at the distribution board should NOT BE GREATER than 5 Amp.

PLEASE NOTE: THE SEVERED PLUG MUST BE DESTROYED TO AVOID A POSSIBLE SHOCK HAZARD SHOULD IT BE INSERTED INTO A 13 AMP SOCKET ELSEWHERE.

The wires in this mains lead are coloured in accordance with the following code:

GREEN and YELLOW	—EARTH
BLUE	—NEUTRAL
BROWN	—LIVE

As the colours of the wires in the mains lead of this apparatus may not correspond with the coloured markings identifying the terminals in your plug, please proceed as follows:

The wire which is coloured GREEN and YELLOW must be connected to the terminal which is marked with the letter E or with the safety earth symbol \perp or coloured GREEN or coloured GREEN and YELLOW.

The wire which is coloured BLUE must be connected to the terminal which is marked with the letter N or coloured BLACK.

The wire which is coloured BROWN must be connected to the terminal which is marked with the letter L or coloured RED.

THIS APPARATUS MUST BE EARTHED

Ensure that all the terminals are securely tightened and no loose strands of wire exist.
Before replacing the plug cover, make certain the cord grip is clamped over the outer sheath of the lead and not simply over the wires.

6D-En

FCC WARNING

This equipment has been tested and found to comply with the limits for a Class B digital device pursuant to Part 15 of the FCC rules. These limits are designed to provide reasonable protection against harmful interference in a residential installation. This equipment generates, uses, and can radiate radio frequency energy and, if not installed and used in accordance with the instructions, may cause harmful interference to radio communications. However, there is no guarantee that interference will not occur in a particular installation. If this equipment does cause harmful interference to radio or television reception, which can be determined by turning the equipment off and on, the user is encouraged to try to correct the interference by one or more of the following measures:

- Reorient or relocate the receiving antenna.
- Increase the separation between the equipment and receiver.
- Connect the equipment into an outlet on a circuit different from that to which the receiver is connected.
- Consult the dealer or an experienced radio/TV technician for help.

21B-En

AVIS POUR LES ACHETEURS CANADIENS DU MPC2000XL

Le présent appareil numérique n'émet pas de bruits radioélectriques dépassant les limites applicables aux appareils numériques de la Class B prescrites dans le Règlement sur le brouillage radioélectrique édicté par le ministère des Communications du Canada.

27-F

This digital apparatus does not exceed the Class B limits for radio noise emissions from digital apparatus set out in the Radio Interference Regulations of the Canadian Department of Communications.

27-En

VENTILATION

Do not prevent the unit's ventilation, especially by placing the unit on the soft carpet, in a narrow space, or by placing objects on the unit's chassis—top, side, or rear panels. Always keep the unit's chassis at least 10 centimeters from any other objects.

31C-En

CHANGES OR MODIFICATIONS NOT EXPRESSLY APPROVED BY THE MANUFACTURER FOR COMPLIANCE COULD VOID THE USER'S AUTHORITY TO OPERATE THE EQUIPMENT.

32-En

COPYRIGHT NOTICE

The AKAI MPC2000XL is a computer-based device, and as such contains and uses software in DISKS and ROMs. This software, and all related documentation, including this Operator's Manual, contain proprietary information which is protected by copyright laws. All rights are reserved. No part of the software or its documentation may be copied, transferred or modified. You may not modify, adapt, translate, lease, distribute, resell for profit or create derivative works based on the software and its related documentation or any part there of without prior written consent from AKAI professional M.I. Corp., Yokohama, Japan.

WARRANTY

AKAI professional M.I. Corp. warrants its products, when purchased from an authorized "AKAI professional" dealer, to be free from defects in materials and workmanship for a period of 12 (twelve) months from the date of purchase. Warranty service is effective and available to the original purchase only, and only on completion and return of the AKAI professional Warranty Registration Card within 14 days of purchase.

Warranty coverage is valid for factory-authorized updates to AKAI professional instruments and their software, when their installation is performed by an authorized AKAI professional Service Center, and a properly completed Warranty Registration has been returned to your "AKAI professional" dealer.

To obtain service under this warranty, the product must, on discovery of the defect, be properly packed and shipped to the nearest AKAI professional Service Center. The party requesting warranty service must provide proof of original ownership and date of purchase of the product.

If the warranty is valid, AKAI professional will, without charge for parts or labor, either repair or replace the defective part(s). Without a valid warranty, the entire cost of the repair (parts and labor) is the responsibility of the product's owner.

AKAI professional warrants that it will make all necessary adjustments, repairs and replacements at no cost to the original owner within 12 (twelve) months of the purchase date if:

- 1) The product fails to perform its specified functions due to failure of one or more of its components.
- 2) The product fails to perform its specified functions due to defects in workmanship.
- 3) The product has been maintained and operated by the owner in strict accordance with the written instructions for proper maintenance and use as specified in this Operator's Manual.

Before purchase and use, owners should determine the suitability of the product for their intended use, and owner assumes all risk and liability whatsoever in connection therewith. AKAI professional shall not be liable for any injury, loss or damage, direct or consequential, arising out of use, or inability to use the product.

The warranty provides only those benefits specified, and does not cover defects or repairs needed as a result of acts beyond the control of AKAI professional, including but not limited to:

- 1) Damage caused by abuse, accident, negligence. AKAI professional will not cover under warranty any original factory disk damaged or destroyed as a result of the owner's mishandling.
- 2) Damage caused by any tampering, alteration or modification of the product: operating software, mechanical or electronic components.
- 3) Damage caused by failure to maintain and operate the product in strict accordance with the written instructions for proper maintenance and use as specified in this Operator's Manual.
- 4) Damage caused by repairs or attempted repairs by unauthorized persons.
- 5) Damage caused by fire, smoke, falling objects, water or other liquids, or natural events such as rain, floods, earthquakes, lightning, tornadoes, storms, etc.
- 6) Damage caused by operation on improper voltages.

IMPORTANT NOTE: This warranty becomes void if the product or its software is electronically modified, altered or tampered with in any way.

AKAI professional shall not be liable for costs involved in packing or preparing the product for shipping, with regard to time, labor, or materials, shipping or freight costs, or time or expense involved in transporting the product to and from AKAI professional Authorized Service Center or Authorized Dealer.

AKAI professional will not cover under warranty an apparent malfunction that is determined to be user error, or owner's inability to use the product.

THE DURATION OF ANY OTHER WARRANTIES, WHETHER IMPLIED OR EXPRESS, INCLUDING BUT NOT LIMITED TO THE IMPLIED CONDITION OF MERCHANTABILITY, IS LIMITED TO THE DURATION OF THE EXPRESS WARRANTY HEREIN.

AKAI professional hereby excludes incidental or consequential damages, including but not limited to:

- 1) Loss of time.
- 2) Inconvenience
- 3) Delay in performance of the Warranty.
- 4) The loss of use of the product.
- 5) Commercial loss.
- 6) Breach of any express or implied warranty, including the Implied Warranty of Merchantability, applicable to this product.

Table of Contents

Chapter 1: Introduction	1
Features	2
Panel Descriptions	4
Front Panel	4
Rear Panel	7
Handling Floppy Disks	8
The Disk Drive	8
Taking care of your Disks	8
CD-ROM Care	9
 Chapter 2: The Basics	 10
Hooking Up Your System	11
The Terms Used in MPC2000XL	12
Sequence	12
Track	12
Song	12
Sound	13
Drum Pads	13
Note Number	13
Program	13
Operating the Front Panel and Screen	14
The Cursor, Cursor Keys, Data Fields	15
The Numeric Keypad and DATA Wheel	15
The Function Keys	15
Basic Functions	16
Loading and Playing Programs	16
Playing the Drum Pads, the PAD BANK, & FULL LEVEL Keys	18
Selecting Programs	19
The NOTE VARIATION Slider, ASSIGN and AFTER keys	19
The ASSIGN Key	20
The AFTER key	21
The 16 LEVELS key	22
 Chapter 3: Recording Sequences	 24
How Sequences are Organized	24
Bar.Beat.Tick	25
Examples of Sequence Recordings	26
Example 1: Recording a Drum Pad Performance	26
Example 2: Recording a Loop	28
Example 3: Recording With External MIDI Equipment	30
The MAIN SCREEN	32
Selecting a Sequence	32
Renaming a Sequence	32
Name Window	33
Deleting a Sequence	33
Copying a Sequence	34
Next sequence function	34
Second Sequence Feature	36

Setting the Tempo	37
Tempo Change Window	37
Entering and Modifying a Tempo Change	38
Selecting a Tempo Source	39
Setting the Time Correct (Quantization)	40
Setting the Beat	41
Setting the Number of Bars	42
Looping a Sequence	44
Setting the Recording Count In/Metronome	45
Selecting a Track	47
Renaming a Track	47
Deleting a Track	48
Copying a Track	48
Turning the Track ON or OFF	49
Deleting All the Tracks that You Have Turned Off	50
Setting the Track Type	50
Settings for MIDI Reception	51
MIDI Filter Function	52
Setting the Track's MIDI Channel	52
Settings for MIDI Output	53
Multiple Track Recording	54
Editing the Velocity	55
Setting the Program Change Transfer	56
Locating with the DATA Wheel	56
Units Used to Locate a Point	56
The Main Screen Function Keys	57
The Play/Record Keys and the Locate Keys	58
The AUTO PUNCH IN/OUT Function	60
Chapter 4: Editing Sequences	61
Overview	62
Erasing Data with the ERASE Key	62
Erasing a Note in Real Time	62
Using the ERASE Window to Erase Data	62
Step Editing	64
Step Editing Screen	64
Timing Correct in Step Edit	65
The Event Display	65
Operating the List Display	66
Selecting and Editing Multiple Events	66
Copying an Event	67
Deleting an Event	67
Pasting an Event	67
Inserting an Event	68
Step Recording	68
The Editing Screen	69
Copying an Event	69
Editing the Duration of a Note	70
Editing the Velocity of a Note	70
Transposing a Note	71
Copying by Bar	72
Rearranging the tracks	73

Sequence Preferences	74
Transposing a Track	74
Chapter 5: Song Mode	76
Overview	76
Song Mode	78
Creating a Song	78
Renaming a Song	79
Selecting a Song	78
Deleting a Song	80
Copying a Song	81
Setting the Tempo	82
Setting the Loop	83
Selecting a Step and Changing a Sequence	84
Repeating a Sequence	84
Deleting a Step	85
Inserting a Step	85
Moving to a Specific Point in a Song (Locate)	86
Converting a Song to a Sequence	87
Chapter 6: Creating and Editing Sounds	88
Sampling a New Sound	89
Editing a Sound	93
Selecting a Sound	93
Renaming or Displaying the Specification of the Sound	93
Deleting a Sound	94
Copying a Sound	94
Converting a Sound	95
Converting Stereo to Mono	95
Converting Mono to Stereo	96
Re-sampling	97
TRIM Mode	98
Fine Adjustment of the Start Point	99
Fine Adjustment of the End Point	100
LOOP Mode	101
Fine Adjustment of the Loop Points	102
ZONE Mode	103
Fine Adjustment of the Start Point of a Zone	103
Fine Adjustment of the End Point of a Zone	104
EDIT Mode	104
BPM Match	107
Setting the Sound Parameters	109
Beat Loop Function	109
Chapter 7: Creating and Editing Programs	110
What Are Programs?	111
Creating a program	112
Selecting a Program and Assigning a Sound	113
Selecting Programs	113
Renaming Programs	114
Deleting a Program	114
Creating New Programs	115

Copying Programs	115
Assigning Notes to the Drum Pads	116
Assigning Sounds to Notes	117
Auto Chromatic Assignment	117
The Pad Assign Mode and Initialize	118
Deleting Unused Sounds from the Memory	118
The Program Sound Generation Mode	119
Editing Note Parameters	121
Selecting Programs	121
Selecting Notes	121
Copying the Note Parameter	122
Setting the Envelope	122
Setting the Filter	124
Setting the Pitch	125
Setting the Voice Overlap	126
The MIDI Settings of the Sampler	127
Chapter 8: Mixer Functions	128
Stereo Output Mixer	129
Setting the Volume	129
Setting the Left/Right Pan	130
Linking the Volume/Pan Levels	130
Setting the Individual Outputs and Effect Send (Option)	131
Assigning the Sounds to Individual Outputs	131
Setting the Output Level	132
Linking the Individual Outputs/Output Levels	132
Sending Effects	133
Setting the Effect Send Level	133
Setting the Volume or Pan for Each Note	134
Setting Up the Mixer	135
Chapter 9: Effects (optional)	137
Editing Effects	138
Turning Each Effect On or Off	138
Multi-effects	139
Setting the Effect Routing	139
Reverb Effects	141
Editing Each Effect	143
Chapter 10: Disk Operation	151
Overview	152
The Device: Field	152
The Device Icons	152
Before Proceeding to Use a Floppy Disk	153
Formatting a Disk	154
Formatting a Floppy Disk	154
Formatting a SCSI Drive	155
Saving the Data	156
Saving Across Multiple Floppy Disks	159
Saving to Folders on a SCSI Device	160
Creating a New Folder	160
Making Folders Within Folders	161

Selecting Folders/Files	162
Deleting Folders	163
Renaming Folders	163
Loading Files	164
Deleting a File from the Disk	168
Loading an Updated Operating System	169
Loading Files Created on the AKAI MPC60/60II	170
Chapter 11: Flash ROM (optional)	172
Formatting the Flash ROM	173
Saving to Flash ROM	174
Loading From Flash ROM	174
Deleting Data from Flash ROM	175
Flash ROM Fragmentation	175
Editing a Sound Within Flash ROM	176
Chapter 12: MIDI/SYNC Mode, OTHER Mode	177
MIDI/SYNC Mode	178
Synchronizing the MPC2000XL with Other Sequencers	178
Synchronizing Another Sequencer or MTR to the MPC2000XL	180
Synchronizing With SMPTE Time Code	182
MIDI Sample Dump	183
MIDI Footswitch Assignment	185
OTHER Mode	186
OTHERS Screen	186
INIT Screen	186
VER. Screen	187
Appendix	188
Notes on Using SCSI Drives	189
Connecting an External SCSI Drive	189
SCSI Cables	189
SCSI ID	190
Termination	190
Cable Length	190
Installing the Options—To Service Technicians	191
Location of MPC2000XL Option Boards	191
Installing Memory Expansion	192
Technical Specifications	193
The MIDI Implementation Charts	195



Chapter 1

Introduction

Features

The following is a summary of some of the advanced features of the MPC2000XL.

General

- Large 248 x 60 dot LCD display with graphics.
- 6 function keys under the LCD display provide various functions on each page.
- Built-in 1.44 megabyte floppy disk drive to store both sequence and sound data.
- By pressing the OPEN WINDOW key at the parameter you want to edit, you are allowed to make more detailed parameter settings. It is not necessary to switch between different pages as in the case of conventional devices to make detail settings.
- Built-in SCSI interface for storing data to external hard disk.

Sampler

- 16-bit, 44.1kHz stereo sampling.
- High capacity sound memory: 2 megabytes standard (22 seconds mono or 11 seconds stereo), expandable to 32 megabytes with SIMM memory.
- Digital sampling input for direct recording from digital sources with IB-M208P (optional) board.
- 256 sounds (samples) may be held in memory at one time.
- 32 simultaneous playback voices.
- The envelope or filter can be set for each sound.
- Optional multi-effects generator EB16 for versatile effects.
- Sample files may be loaded from Akai S1000 and S3000 disks.
- IB-M208P (optional) enables you to mix and output internal sampler sounds from 8 individual outputs.
- A maximum of 24 programs (sound assignments and sound parameter settings) can be created.
- A maximum of up to 4 programs can be played simultaneously.
- A selection between polyphonic (multiple sounds are overlaid when the same sound is played continuously) or mono (the second sound silences the first).
- It is possible to stop the playing of a sound with another sound. This is used to simulate the open close effect of the hi hat.
- It is possible to copy a part of a sound as a separate sound or paste a sound to a section of a sound. It is also possible to mute or reverse part of a sound.
- One MIDI note can play three sounds. The sounds can be played simultaneously, switched by velocity, or with the NOTE VARIATION slider.
- Loop settings can be made to a sound.
- The velocity can change the playback pitch..
- When phrase sampling, it is possible to calculate the tempo of the phrase from the length of the sound loop.
- Since the sound wave patterns are displayed, it is possible to edit the sound while watching the wave pattern. It is also possible to zoom the wave pattern.
- Reading and writing of PC compatible .WAV sound files.
- Timestretch, resample, wave pattern edit functions, etc. are available.

Sequencer

- Loop recording function enables quick recording by looping short phrases.
- Sequencer memory equivalent to 300,000 notes (including note and other data).
The maximum number events in a sequence is equivalent to 50,000 notes.
- 99 sequences may be held in memory at once. Each sequence contains 64 individual tracks.
- 2 independent MIDI output ports permit 32 simultaneous MIDI output channels.
- 2 mergeable MIDI inputs.
- The optional SMPTE IC chip (IC-M2TC) enable synchronization with SMPTE time codes.
- MTC (MIDI time code), MMC (MIDI machine control) compatible.
- Data can be exported to or imported from standard MIDI files.
- Step edit function enables you to edit individual events.
- The velocity of each track can easily be modified.
- It is possible to record to 32 MIDI channels at one time.
- Tap Tempo feature allows the playback tempo to be set by tapping a key in the time of 1/4-notes.
- Programmable tempo changes in mid-sequence or mid-song are supported.
- Auto Punch feature enables you to punch in or punch out automatically in the designated sequence.
- Swing feature enables you to add a swing-feel to the rhythm.
- 16 velocity- and pressure-sensitive front panel drum pads and 4 pad banks provide a total of 64 pad/bank combinations.
- Track mute can be turned on or off and sequences can be selected using the drum pads.
- The NOTE VARIATION slider controls the decay or filter value of the sound in real time.
- Since it is possible to convert MIDI sustain pedal data to note duration data, you can place sustain effects independently from the note data within a track.
- The note repeat function and the after touch function pads enable you to easily enter drum rolls and hi-hat beats.
- The UNDO SEQ key enables you to undo sequence recordings or edits.
- The 2nd sequence function allows a separate sequence to be played at the same time that another sequence (or song) is being played/recorded.

Panel Descriptions

Front Panel

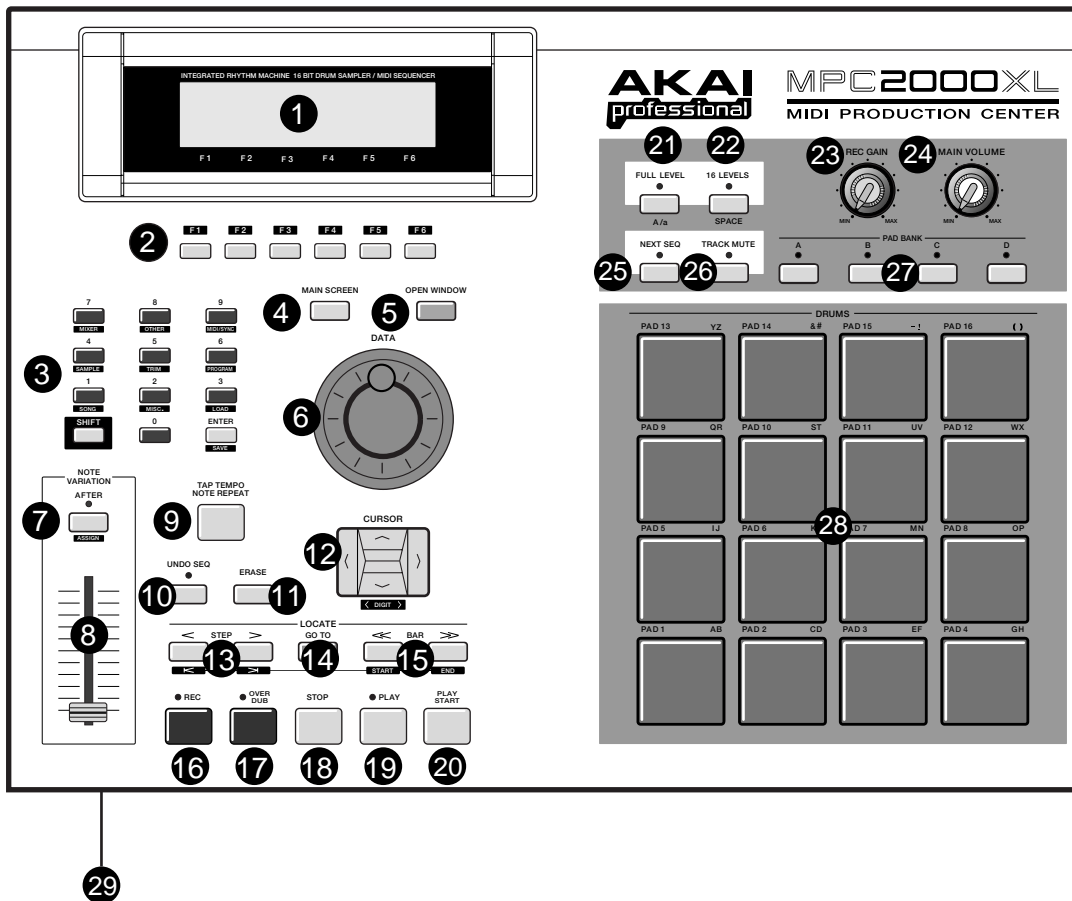

① LCD

All the function windows are displayed here. This adjustable display can be tilted to 3 different angles for clearer viewing.

② Function keys

These keys execute the function shown on the very bottom of the display.

Functions surrounded by a rectangular frame **SOLO** can be executed.

Letters without a surrounding box, indicate the currently selected page.

Reversed display **EDIT** indicates that you can jump to that page by pressing the corresponding key.

③ Numeric keys / Mode keys

These allow you to directly enter numeric data. Enter numbers with these keys into selected numeric fields and press the ENTER key.

If you are entering numbers with a decimal

value, enter the number ignoring the decimal point. (example: 120.5, enter 1205.)

If you make a mistake, it is possible to cancel by pressing the SHIFT key before the ENTER key.

If you use the CURSOR keys, DATA wheel, or MAIN SCREEN key while you are entering data with the numeric keys, the input will be canceled and the data returns to the status before entry the entry was made.

By holding the SHIFT key and pressing one of the numeric keys, the key functions as a Mode key and allows you to enter the mode indicated under the key.

④ MAIN SCREEN key

This allows you to return from any page to the MAIN screen (initial screen). The MAIN screen is the basic screen used to record or play back a sequence.

⑤ OPEN WINDOW key

When certain fields are selected, pressing this key opens another window to allow you to set further data related to that field.

Pressing the key again closes the window.

⑥ DATA wheel

This allows you to change the numbers or data of the selected field. The data variably increases the faster the wheel is turned.

To set the contrast of the LCD, rotate the DATA wheel while holding down the SHIFT key. This can be done at any time, regardless of the mode you are in.

⑦ NOTE VARIATION/AFTER key

Normally, the NOTE VARIATION slider is used when the drum pad is played or when the drum pad performance is recorded to a sequence.

However, by pressing this key, it is possible to use the NOTE VARIATION slider while the sequence is playing. This also needs to be on when you are overdubbing only the NOTE VARIATION slider effect.

⑧ NOTE VARIATION slider

This enables you to change the parameters of the preset internal sound source.

Hold down the SHIFT key and press the AFTER key to display the screen and then change parameters (TUNING, DELAY, ATTACK and FILTER) with the slider.

⑨ TAP TEMPO / NOTE REPEAT key

This allows a sequence to play at the tempo set by hitting the key.

Hold this key and press one of the drum pads to play to the beat set in the Timing field on the MAIN screen. For example, if the Timing is set at 1/8, you can play the hi-hat at an eight beat by holding this key and pressing the drum pad that is assigned to the hi-hat.

This button only operates during the play and record modes.

If you hold down this key and then press SHIFT, the NOTE REPEAT feature will be locked and you can release the buttons and just press the drum pad. Press NOTE REPEAT again to release the lock mode.

The length that the drum pad is held determines the note's velocity.

⑩ UNDO SEQ key

When you record and stop a sequence, the indicator above this key will light. It is now possible to return the sequence back to the original state before recording by pressing this key (the light will go out). If the key is pressed again, the indicator will light and the state will return to the condition after the last recording. This is convenient for comparing the recording with the previous one, or to undo a poor recording.

You can only use the UNDO SEQ key when you are recording or editing a sequence. You cannot use this key when you are editing a program or sound. Using the UNDO SEQ is also limited to the time just after a recording or edit. If you move to another mode or function screen, the UNDO SEQ mode will be disabled.

⑪ ERASE key

This is used to erase data on the selected track.

By holding this key and pressing the drum pad of the sound that you want to erase, while dubbing over a sequence, you can erase the data (as long as the PAD is pressed). In addition to drum tracks, you can erase the notes on a track of an external MIDI device by holding this key and pressing the note that needs to be erased on the MIDI keyboard. The ERASE window will appear if you press this key while a sequence is not playing. This allows you to erase specific notes or lengths of data.

⑫ CURSOR key

This moves the cursor to select the parameter that you want to edit. The currently selected field is displayed by white figures on a blue background.

To enter large numbers (when using the trim mode, for example, to edit sounds) press CURSOR LEFT/RIGHT while holding down the SHIFT key.

⑬ STEP < / > key

This locates the sequence point backwards and forwards one step at a time. The step is set in the Timing field of the MAIN screen. When Timing is OFF, you can move a step by one clock. HOLD the GO TO key and press this key to locate the position of the next/previous event recorded on a track.

⑭ GO TO key

This key displays the locate window. Enter the locate point or move the cursor to the memorized locate point and then press GO TO [F5]. To memorize a locate point, pick a point that you want to memorize and display the Locate window by pressing the GO TO key, then move the cursor to the number you want to memorize and press the STORE [F2] to memorize the point.

15 BAR << / >> key

This locates the sequence point by bars. Holding the GO TO key, press this key to locate the start or end point of the selected sequence.

16 REC key

While holding this key, press the PLAY key or the PLAY START key to begin sequence recording. If there is data on the track, it will be erased by the new recording.

17 OVER DUB key

While holding this key, press the PLAY key or the PLAY START key to begin sequence recording. The new recording is dubbed over the data on the track, adding to the original data.

18 STOP key

This stops the playback or recording of a sequence.

19 PLAY key

This starts the sequence from the current point ("FLOW#" on the MAIN screen). It is also possible to select "FLOW#" with the CURSOR keys and set the position for playback/recording with the DATA wheel.

20 PLAY START key

This starts the sequence from the beginning.

21 FULL LEVEL key

When this key is pressed and the light is on, regardless of how hard the drum pad is hit, the sound will always be generated at full velocity.

Also used to selected upper or lower case letters when naming sounds, sequences, etc.

22 16 LEVELS key

This allows you to assign one selected sound to all 16 pads and set and play the sound at 16 parameter levels of velocity, tone, attack, decay, or filter.

23 REC GAIN knob

This adjusts the level of the sound coming from the RECORD IN jack during a sampling.

24 MAIN VOLUME knob

This adjusts the volume of the STEREO OUT and PHONES jacks. However, this does not adjust the volume of the optional "assignable mix out" outputs.

25 NEXT SEQ key

Pressing this key will display the NEXT SEQ screen that allows you to select another sequence to play directly following the one already selected.

Although the NEXT SEQ function can be used with the main screen, the NEXT SEQ screen provides a wider range of convenient functions that can be used.

26 TRACK MUTE key

When this key is pressed and the indicator lights, you can mute tracks by pressing the corresponding drum pad (pressing the pad again turns the track back on). Press the TRACK MUTE key again to cancel the mode.

27 PAD BANK A-D keys

There are four pad banks from A to D and each has sixteen sounds, so it is possible to use 64 different sounds by switching banks. The indicator will light for the currently selected bank.

28 Drum pads

These play back sounds (samples, etc.), including the drum sounds in the memory.

The loudness of the sounds depend on how hard you hit the pad.

You can assign up to 64 sounds to the 16 drum pads by using the 4 pad banks A-D.

29 Floppy disk drive

The floppy disk drive is used to load or save sound or sequence data. Both 2HD and 2DD floppy disks can be used.

Rear Panel

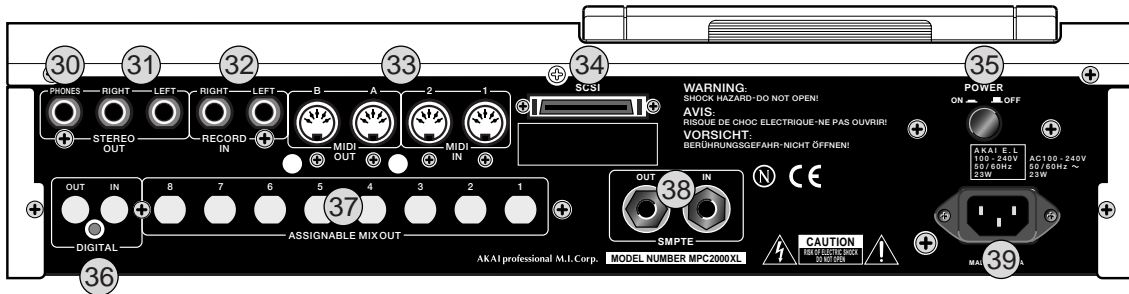

30 STEREO OUT PHONES

Connect your stereo headphones here. The same sound is output to the STEREO OUT LEFT and RIGHT jacks.

31 STEREO OUT LEFT/RIGHT

These are the main output jacks.

32 RECORD IN

These are the input jacks used for sampling. These stereo phone jacks are balanced inputs.

33 MIDI IN

These receive MIDI signals. MIDI 1 and 2 signals are merged.

MIDI OUT

These send MIDI signals. Since A and B are independent, it is possible to handle a total of 32 MIDI channels.

34 SCSI

This is a 50 pin SCSI interface connector that you can connect to external disk drives for loading and saving data.

35 POWER

This is the power ON/OFF switch.

36 DIGITAL IN/OUT (option)

This allows you to sample data directly from an audio CD or DAT. It is also possible to record the entire digital data from this output to a hard disk recorder or DAT, such as the AKAI DR16 or DPS12.

37 ASSIGNABLE MIX OUT (option)

This allows you to set up to 8 separate outputs for individual sounds. This gives you more control of the mixing of the sounds, especially when using an external mixer or effects unit.

38 SMPTE IN/OUT (option)

If the unit is equipped with the SMPTE option, these jacks are used to synchronize to a tape that uses the SMPTE time code.

39 AC in

Connect the provided power cable here.

Handling Floppy Disks

The Disk Drive

The 3.5 inch floppy disk drive will accept high density and low density disks.

Disks are inserted into the drive thus:

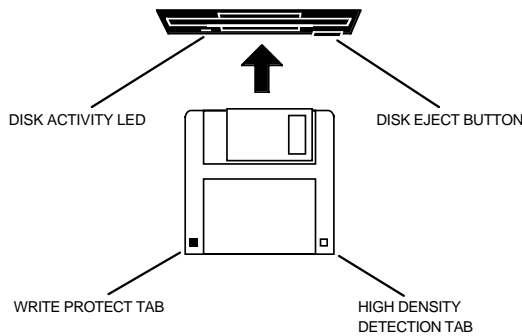

The label should be facing upwards when it is inserted (actually, it is physically impossible to insert disks the wrong way round without using an extreme amount of brute force!).

To eject the disk, simply press the DISK EJECT button. When a disk is loading, saving or formatting, the DISK ACTIVITY LED will be lit. Never eject a disk while the DISK ACTIVITY LED is lit.

As a result, it is vital that you save your work to disk before turning the power off otherwise you will lose your work and, unless previously saved or backed up, it will be gone for ever. In fact, it is a good idea to

regularly save your work as you are working. All good computer users do this and it prevents the accidental loss of data should power be accidentally removed from the instrument. This also serves as a form of 'undo' - if you make some kind of mistake in your programming and editing and can't fix it, you can load the last level of editing back into the unit. It may be a bit tedious to keep stopping every now and then to save your work but it is better than losing some valuable sounds.

Taking care of your Disks

Floppy disks contain valuable sound data and, as such, should be treated with extreme care. Please observe the following points, therefore:

1. Never slide the metal cover back and touch the disk. Finger marks may render the disk unreadable.
2. Don't leave the disk in the drive whenever possible. When the disk is in the drive, the metal protective cover slides back exposing the actual disk inside and this makes the disk susceptible to picking up dust which may cause read errors.
3. Do not leave your disks in a hot car.
4. Do not place your disks next to any magnetic sources such as speakers, amplifiers, televisions, etc.. Also, try to avoid X-ray machines. At airports, it is sometimes possible to ask for your disks to be inspected by hand at security desks but, with the added security at airports these days, this may not be possible. Always check with the security officer though, just in case. Security X-ray machines are generally safe with disks, though. If in doubt, make backup copies which should be left at home.

Note: *Some checked-in luggage is X-rayed by quite powerful machines that are not as safe as those that check hand luggage. It is probably best to take your disks as hand luggage.*

5. Do not leave your disks around when drinking liquids - one accidental spillage could ruin a lot of work!
6. Always use high quality disks. Whilst cheap ones may be appealing, they are prone to errors more than good ones.
7. Try to ensure that the write protect tab is switched on (i.e. the tab does not block the hole). This will prevent accidental erasure, formatting and loss of data. It may be a nuisance to try to write to the disk and find it write protected but it is less of a nuisance than accidentally over-writing a set of your favourite samples and programs!
8. Try to get into the habit of labelling your disks - it will pay dividends in the end when you are searching for something.
9. Invest in a sturdy carrying case for your floppies especially if you are a gigging musician. Heavy duty metal camera cases are ideal and some flight case manufacturers now make special heavy duty disk flightcases.
10. Even if you are using a hard disk of any sort, please make sure you have backed up your work to floppy disks. It can be time consuming but it will be worth it if you ever have a problem with your hard disk!

CD-ROM care

Dust, dirt, scratches or warps on the CD-ROM may lead to faulty CD-ROM data loading. In order to take full advantage of the CD-ROM player's performance capabilities, follow the precautions outlined on this page.

Disc handling

Hold the CD-ROM by the outer edge only, supporting it at the center with your index finger if necessary.

Avoid touching the unprinted side of the disc.

Do not glue any labels or stickers etc., on the disc.

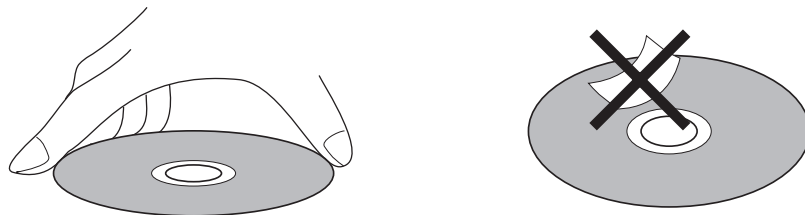

Disc storage

Do not store the CD-ROM in a location which is subject to direct sunlight, high humidity, or hot air from heating appliances.

Always return the CD-ROM to their plastic cases for storage.

Disc cleaning

It is recommended that you periodically wipe the recorded side of your CD-ROM with a commercially available silicone cloth (such as that used for cleaning camera lenses or glasses) in order to remove dust, dirt or fingerprints. Wipe the disc gently, being careful not to scratch its surface.

When wiping the disc, refer to the illustrations below. Unlike records, CD-ROM should always be wiped in a straight line from the center to the edge.

Do not use volatile chemical substances such as denatured alcohol, cleaning fluid intended for analog records, or antistatic fluids, as these may damage the CD-ROM.

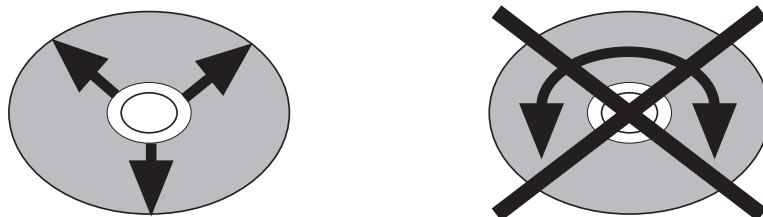



Chapter 2

The Basics

Hooking Up Your System

The following diagram shows how to hook up the MPC2000XL to a MIDI keyboard, two sound modules and a CD ROM.

You can connect other external SCSI devices (such as a hard disk, ZIP drive, etc.) to the SCSI interface on the rear panel so that you can save or load samples, songs, etc.

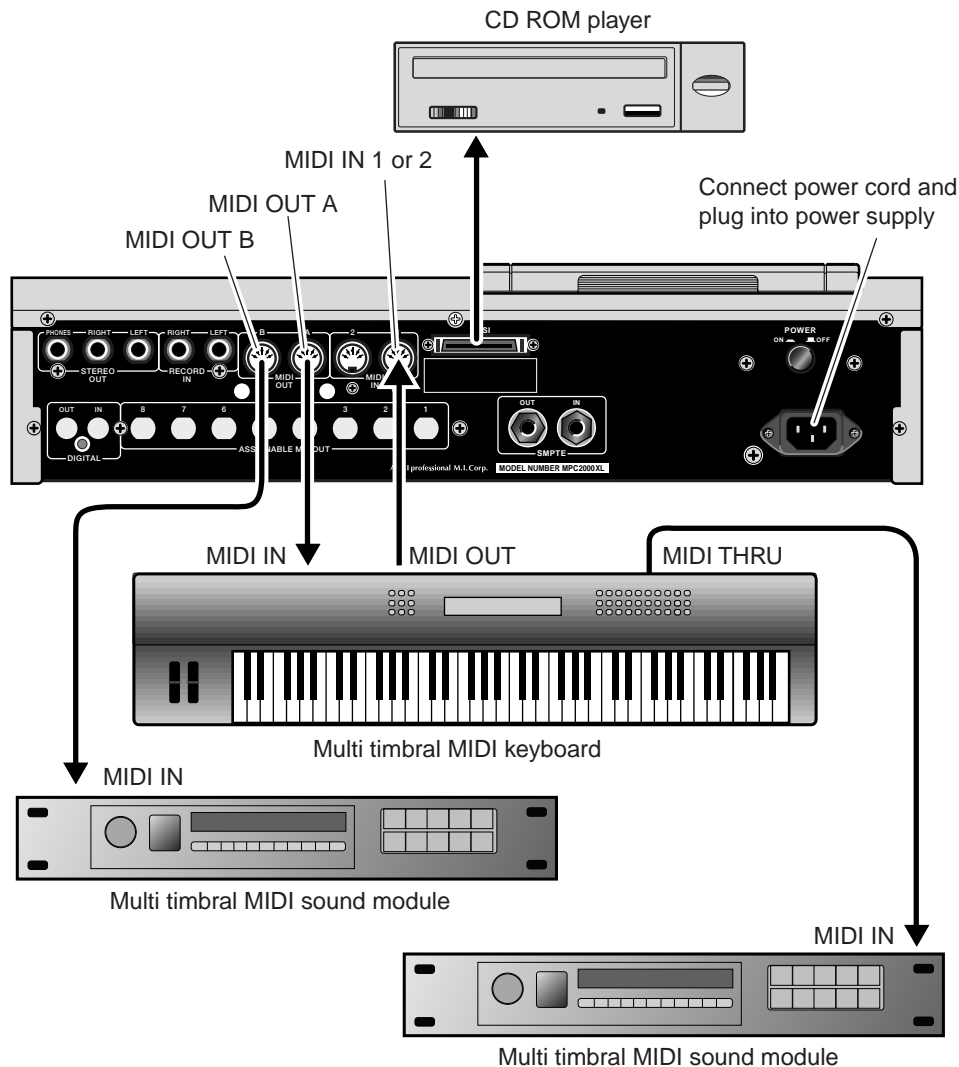

If you only want to use the MPC2000XL as a drum machine for now, don't connect the MIDI keyboard, the sound modules, or make any MIDI connections. If you choose to connect an external MIDI device, connect the MIDI Output of the MIDI keyboard to MIDI Input of the MPC2000XL, and the MIDI Input of the MIDI sound source to MIDI Output of the MPC2000XL. MIDI Output provides an A or B Output. Normally use Output A when there is only one sound source. If you want to use a sound source from the connected MIDI keyboard, connect the MIDI keyboard MIDI Input to the MPC2000XL MIDI Output. (In this case, it is necessary to turn the Soft thru function on the MPC2000XL off. For details, refer to "Setting the Track's MIDI Channel" on page 52.) To connect multiple sound sources, use the MIDI THRU jacks of the MIDI device. Connect the MIDI Output of the MPC2000XL to the MIDI Input of the first MIDI sound source. Connect the MIDI THRU of the first MIDI sound source to the second MIDI sound source, and so on. MIDI can handle up to 16 data channels, the MPC2000XL has MIDI Output A and B each with 16 channels enabling you to handle 32 channels of data.

The Terms Used in MPC2000XL

Here are some definitions of terms used in the MPC2000XL that you should know:

Sequence

A sequence is the most basic unit in creating data on the MPC2000XL. The performance data from a MIDI keyboard or pad is recorded on each track within a sequence. Each sequence has 64 tracks, to which performance data can be recorded. It is possible to create up to 99 sequences.

Sequence	
Track 01	Piano
Track 02	Bass
Track 03	Organ
↓	
Track 64	(Unused)

Although data equivalent to a maximum total of 300,000 notes can be recorded on the MPC2000XL, the number of notes that can be recorded within one sequence is limited to a maximum 50,000 notes.

Note: *It is not possible to Load/save sequence data that exceeds the 50,000 note limit. When a sequence file that exceeds 50,000 notes is stored on the MPC2000 using the ALL mode, only 50,000 notes of data will be read when this file is loaded. In this type of case, use the MPC 2000 to create a separate sequence of the data that was cut from the original sequence read into the MPC2000XL, then load this into the MPC2000XL and connect and play the 2 sequences using the SONG mode.*

Track

There are 64 tracks in a sequence to which individual performances can be recorded. For example, track 1 could be the piano, track 2 could be the bass, and track 3 the organ. Normally, each track is recorded one at a time. It is also possible to record a new track while playing the recorded tracks. Each track can be turned on or off individually. It is possible to record different piano solos to track 1 and track 2 and compare the combination with the other tracks. You can select either a Drum track or MIDI track. The drum track plays the recorded data of the internal sampler. The MIDI track plays the sound of the external MIDI sound source connected to MIDI OUT.

Song

This function sequentially plays the data of a sequence. You can set the order or number of times to play the sequence. This is used to play multiple pieces consecutively, or to complete a song by arranging the sequence data for each part. In the MPC2000XL there are 20 songs, each having up to 250 steps. A sequence is assigned to each step to create a song. In doing so, it is also possible to set each step to repeat a number of times.

Song		
Step	Seq	Repeats
1	1	2
2	103	1
3	1	2
4	23	3
⋮		
250		

Sound

Each individually sampled recording in the MPC2000XL is called a sound. A sound can be recorded or loaded from a disk. The start or end of a sound can be changed or the looping of a sound can be set on the TRIM page. The sound is assigned to a note number and it is possible to set the envelope, filter, or pitch. Assign a note number to each pad to play the sound from the MPC2000XL drum pads.

Drum Pads

Sounds are played by assigning them to a drum pad. It is possible to assign up to 64 sounds by combining the pads with the pad bank keys (16 pads x 4 pad banks). To play a sound from a pad, assign a sound to a note number then assign the note number to a pad. Details are described in the "Creating and Editing Programs" chapter. By playing a pad, it is also possible to send the MIDI note of the note number assigned to that pad from the MIDI output.

Note Number

This refers to the position (note) of the MIDI note event on the keyboard. For example, the note number for Middle C on the piano is 60. The lowest key on the piano is A-1 which is note number 21. On a MIDI track, the MIDI keyboard performance data is recorded as a note number. On a Drum track, the note number is used to play back the sound in the internal sample. If you play the pads and record to a drum track, the note numbers assigned to the pad will be recorded on the track. When you play back this track, the sound assigned to the note number is played back.

Program

A program is a collection of sounds assigned to 64 note numbers. It is possible to set the envelope or filter on each note number individually. It is possible to create 24 programs on the MPC2000XL. The sound is played back by a pad or MIDI note only when it is assigned to a note number in a program. By assigning a note number to a pad, the sound assigned to that note number can be played from a pad. When a sequence is played back, the sound is played with the note data recorded on the track. (When the snare drum is assigned to note number 50, the snare drum is reproduced with the timing recorded on note number 50.)

You can instantly switch the program by selecting it in PROGRAM mode. It is also possible to use the MIDI program change feature to switch programs.

A maximum of up to 4 separate programs can be played simultaneously on the MPC2000XL.

Operating the Front Panel and Screen

Before you can use the MPC2000XL, you must learn how to use the cursor keys, data fields, numeric key pad and Function keys.

Turn the power on. After the initial loading screens, the following screen will appear:

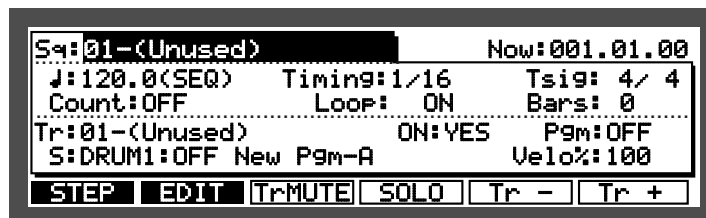

This is the **Main Screen** and most playback and recording of sequences is done with this screen displayed. It is discussed further in the chapter entitled “Recording Sequences.”

If at any time while operating the MPC2000XL you are confused and want to return to this screen, press MAIN SCREEN.

The Cursor, Cursor Keys, Data Fields

Make sure that the Main Screen is showing. If not, press MAIN SCREEN.

The cursor is displayed as white letters on a blue background. You can move the cursor around the screen using the four CURSOR keys located on the front panel. These four keys are referred to as the CURSOR LEFT, CURSOR RIGHT, CURSOR UP and CURSOR DOWN keys in the manual. Try moving the cursor around the screen, then move it back to the upper left corner.

Notice that the cursor does not move from letter to letter, but lands only in certain locations, usually to the right of a colon (:). These areas are called data fields and each one controls a specific parameter. For example, the upper left-most data field is called S-# (an abbreviation for sequence). To the right of this field is another field containing the name of the selected sequence.

The Numeric Keypad and DATA Wheel

Make sure that the Main screen is displayed. If not, press MAIN SCREEN.

To change the data in a field, move the cursor to the field and use the DATA wheel. By rotating the DATA wheel one click to the right, the number will increase. By rotating the DATA wheel one click to the left, the number will decrease. If you continuously rotate the DATA wheel, the numbers will continuously increase or decrease.

There are fields in the data field where you can enter the numbers directly with the numeric keys. Move the cursor to the field, enter a new number from the numeric keys, and press ENTER. For example, to change the tempo to 100.0, follow the steps below:

1. Move the cursor to the : J# (Tempo) field.
2. Enter 1000 (ignoring the decimal point) with the numeric keys and press the ENTER key.

There are also fields that select functions instead of entering numbers. Rotate the DATA wheel to select these functions. For example, move the cursor to the Timing field. Rotate the DATA wheel one click at a time and check the display change in the field. After you have finished, turn the field back to "OFF".

The Function Keys

Make sure that the Main Screen is showing. If not, press the MAIN SCREEN key.

Immediately below the LCD screen are six keys labeled F1, F2, F3, F4, F5 and F6. The functions of these keys change from one screen to the next; these functions are always displayed on the lowest line of the screen. For example, while the Main Screen is showing, the bottom line appears as:

STEP **EDIT** TrMUTE SOLO Tr - Tr +

When a function has a frame such as **SOLO**, that function will be carried out. When the function is reversed such as **EDIT**, you can move to that page by pressing the corresponding function key (press **EDIT** [F2]). If only characters are displayed such as **EVENTS**, it means that that is the currently selected page.

Most of the screens in the MPC2000XL have function key displays, and the lowest line of each of these screens indicates the function of the six function keys while the selected screen is showing. Some screens have less than six active function keys and some have none.

Basic Functions

Loading and Playing Programs

All sounds and programs are stored on the memory held in RAM and the data is therefore lost whenever the power is turned off. In order to play any sounds after turning the power on, you must load them in from the CD or external device connected to the rear panel SCSI interface. The procedure for loading files from a disk is described in the "Disk Operation" chapter, but to get you started, the following steps enable you to load sounds from the enclosed CD and play them from the drum pads:

Please note:

You must have a CD ROM player connected to the MPC2000XL in order to load the sounds described here.

- ① Insert the enclosed CD into the CD ROM player.
- ② Hold down SHIFT and press LOAD (3 on the numeric keypad).

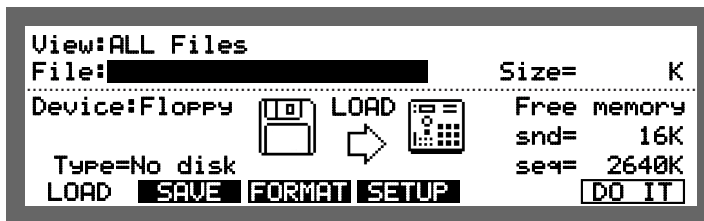

- ③ Move to the Device: field with the CURSOR keys and select the SCSI ID number of the CD ROM with the DATA wheel.

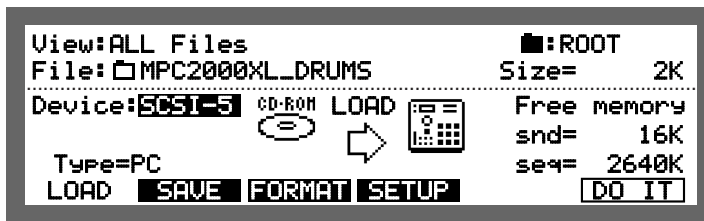

- ④ Move to the File: field with the CURSOR keys and press OPEN WINDOW. The MPC2000XL_DRUMS file will be selected.

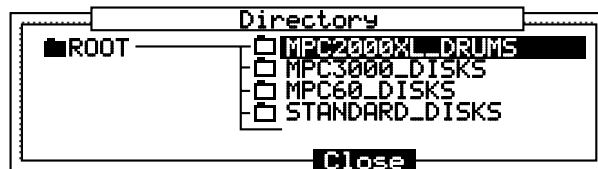

- ⑤ Press the RIGHT CURSOR key to open the file and then select a drum set file (ambience, dry or gated) with the UP/DOWN CURSOR keys.
In this example, we will choose the ambience drums.



- ⑥ Press the RIGHT CURSOR key to open the file and then select AMBIENCE_SET__1.PGM with the DATA wheel.



- ⑦ Press Close [F4]. AMBIENCE_SET__1.PGM will be displayed in the File# field.

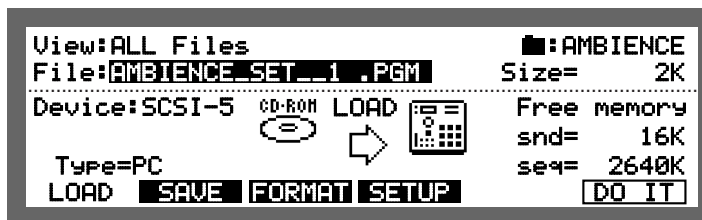

- ⑧ Press DO IT [F6] and then press CLEAR [F3].

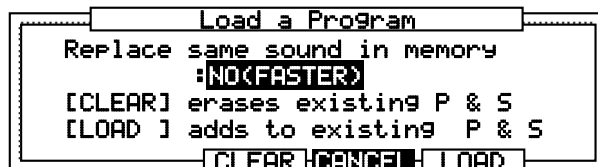

- ⑨ The loading screen will appear.

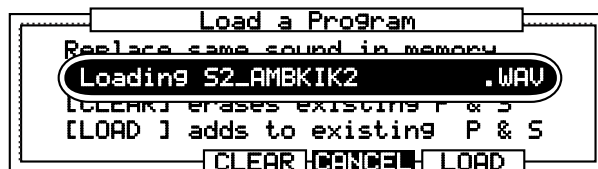

- ⑩ When loading is finished, press MAIN SCREEN and try the sounds by hitting the drum

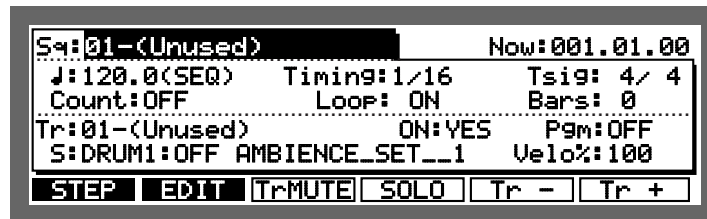

Playing the Drum Pads, the PAD BANK & FULL LEVEL Keys

Each recorded sample is called a sound. To hear some of the drum sounds you have loaded, play the 16 drum pads on the front panel. To hear other sounds, press the A, B, C or D PAD BANK keys, then play the pads again.

The 64 bank/pad combinations are as follows:

- Drum pads in bank A: A01 through A16
- Drum pads in bank B: B01 through B16
- Drum pads in bank C: C01 through C16
- Drum pads in bank D: D01 through D16

The 16 drum pads are dynamic—the harder you play them, the louder the sound will play. Press the FULL LEVEL key (the indicator lights), and no matter how hard you play the pads, the sound will play at its maximum dynamic level. Press the FULL LEVEL key again to return to normal dynamic operation.

Selecting Programs

A program is an edited set with note numbers and sounds assigned to it. The MPC2000XL can hold up to 24 programs. Each program has 64 sound assignments. If you change from one program to another, playing the four banks of pads will produce entirely different sounds.

When you played the drum pads, you were hearing the sounds assigned in Program 1. To change to Program 2:

1. Hold down SHIFT and press PROGRAM (6 on the numeric keypad). The DRUM select screen will appear:
2. Select DRUM 1, 2, 3 or 4.

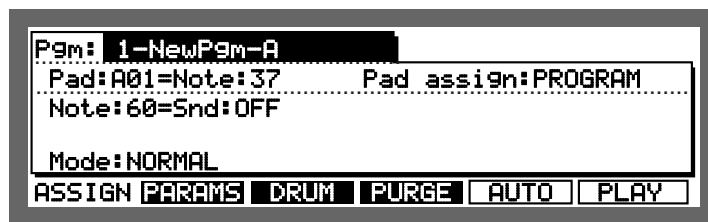

3. Move the cursor to the Pgm# field. Select program 2 using the DATA wheel.
4. Play the sounds in program 2: Select Pad Bank A and play the sounds, then select Pad Banks B, C and D.
5. Repeat step 3, except select program 3 and play the sounds. Repeat this procedure to hear the other programs.
6. To return to the Main Screen, press MAIN SCREEN.

The NOTE VARIATION Slider, ASSIGN and AFTER keys

The NOTE VARIATION slider can be used to change the tuning, attack, decay, or filter value for a sound assigned to a drum pad by moving the slider while playing the pad.

Here are some examples for uses of NOTE VARIATION slider:

1. The slider can control the decay for a hi-hat sound. This would simulate the action of a drummer's hi-hat pedal, changing the hi-hat decay time each time the pad is played. By using the decay switch feature in the program and setting the sound so it switches according to the decay value, it is possible to simulate a closed hi-hat gradually opening by moving the slider.
2. The slider can be assigned to tuning for a tom tom. By moving the slider when playing the drum pad assigned to a tom tom, it is possible to change the tunings.
3. The slider can control the filter value for a sound containing a filter setting. This will change the sound each time the note is played, to play analog synthesizer samples and hold filter effects.

The NOTE VARIATION slider data is recorded onto a sequence with the drum notes. For details about this, please refer to "Step Edit" of the "Editing Sequences" chapter.

The ASSIGN Key

To assign a pad and parameter to the NOTE VARIATION slider, hold down SHIFT and press AFTER (ASSIGN). The following screen will appear:

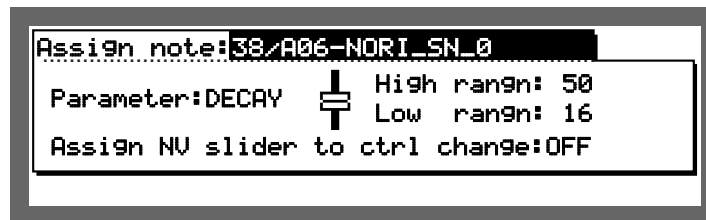

To assign the slider to a drum pad and parameter:

1. Press the drum pad you want to assign to (the note number, pad number and sound name of the pad you pressed will appear in the Assign note: field). You can also select the sound by selecting the Assign note: field with the cursor and using the DATA wheel.
2. Move the cursor to the Parameter: field and select the desired parameter (TUNING, DECAY, ATTACK or FILTER) using the DATA wheel, then assign the related settings.
3. Press MAIN SCREEN to return to the Main Screen.
4. Play the selected pad while moving the NOTE VARIATION slider. Each time the pad is played, the selected parameter (tuning, attack, decay or filter) will change according to the slider position.

Additional information about the four fields:

- **Assign note:**
This field contains the note number to which the slider is assigned (35-98). To change the assignment, press a drum pad. The pad number of the pad you pressed in the Assign note: field and the name of the sound currently assigned to the note number will appear. Alternately, you can change it by moving the cursor directly to the field and rotating the DATA wheel. To turn this function off, turn the DATA wheel to the left until OFF appears.
- **Parameter:**
This field determines which of the four possible parameters the slider will control. The four choices are:
 - TUNING** This slider changes the tuning of the sound. The tuning you get is based on the tuning that is set in the Tune: parameter of the program.
 - DECAY** This enables you to change the decay time with the slider. This changes regardless of the value set in the Decay: parameter of the program.
 - ATTACK** This enables you to change the attack time with the slider. This changes regardless of the value set in the Attack: parameter of the program.
 - FILTER** This enables you to change the cut off frequency of the sound with the slider. This changes the Freq: value of the parameter in the program.

- **Low range:** and **High range:**
These two fields control the range of the slider effect. The **Low range:** field determines the parameter value that will be produced when the pad is hit while the slider is at the bottom of its travel; the **High range:** field determines the parameter value that will be produced when the pad is hit while the slider is at the top of its travel. The parameter value consecutively changes in any position within the range. The available range for this field is determined by the parameter selected in the **Parameter:** field.

TUNING: -120 ~ +120
ATTACK: 0 ~ 100
DECAY : 0 ~ 100
FILTER: -50 ~ +50

Note: The attack or decay changes within the range of 0 and 5000msec.

- **Assign NY slider to ctrl change:**
This field selects the MIDI Control Change Number which controls the NOTE VARIATION slider from an external MIDI controller.

The AFTER key

Normally, the slider only affects notes which are actually played and has no effect on notes played back from sequences. However, if the AFTER key is pressed (and the indicator lights), the slider also effects the drum notes playing back from sequences. In this case, the function effects the drum note of the note number (drum pad) assigned to the NOTE VARIATION slider. Also, this NOTE VARIATION slider data can be recorded if you are in the Overdub mode.

To return to normal operation, press the AFTER key again and the light will go off.

The 16 LEVELS key

By using the 16 LEVELS function, you can play a sound in 16 parameter levels of velocity, tone, attack, decay, or filter.

To use the 16 LEVELS function, in the Main Screen, press the 16 LEVELS key to display the following screen.

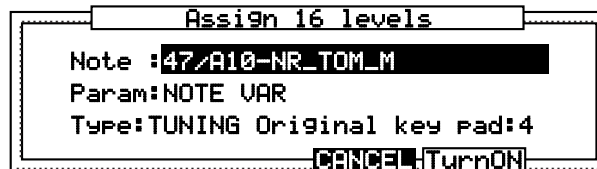

- **Note:**
Use the 16 level feature to select the pads you are playing to 16 levels. Select the sound by directly playing the drum pad. It is also possible to move the cursor to the field and select the pad with the DATA wheel.
- **Param:**
When VELOCITY is selected, it is possible to apply 16 levels of velocity to the sound set in Note#. The velocity is played the weakest on PAD1 and strongest on PAD16.
When NOTE VAR is selected, set the parameter with the following Type#.
- **Type:**
This allows you to select the following parameter.
 - TUNING** This allows you to play the sound set in Note# at 16 levels of tuning. The original tuning is assigned to the pad set in the Original key pad# field and the tuning changes by a semi-tone.
 - DECAY** This allows you to play the sound set in Note# at 16 levels of decay time. The range of decay time is set on the assign screen of the note variation by pressing the ASSIGN (AFTER) key while holding down the SHIFT key.
 - ATTACK** This allows you to set the attack time of a sound set in Note# at 16 levels and play them. The range of the attack time is set on the assign screen of the note variation by pressing the ASSIGN (AFTER) key while holding down the SHIFT key.
 - FILTER** This allows you to set the cut off frequency of the filter of a sound set in Note# at 16 levels and play them. The range of the cut off frequency is set on the assign screen of the note variation by pressing the ASSIGN (AFTER) key while holding down the SHIFT key.

After you have set the parameter, press TurnON [F5]. The 16 LEVELS LED indicator will light and allow you to play using the 16 levels function.

Press the 16 LEVELS key again to turn the 16 LEVELS function off.



Chapter 3

Recording Sequences

How Sequences are Organized

A sequence is the most basic unit for creating on the MPC2000XL. The performance data from a MIDI keyboard or pad is recorded on each track within a sequence. Each sequence has 64 tracks, to which performance data can be recorded. It is possible to create up to 99 sequences.

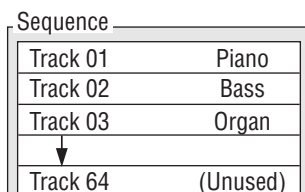

There are two main ways to create music on the MPC2000XL. One way is to create a long sequence as a whole song, the other way is to create short sequences and join them together to make a song. Therefore, a sequence can be a long piece of more than 100 bars or a two-bar drum loop

One sequence as a whole piece.

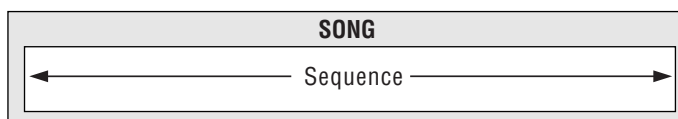

A multiple sequence piece (setting short sequences with the Song function).

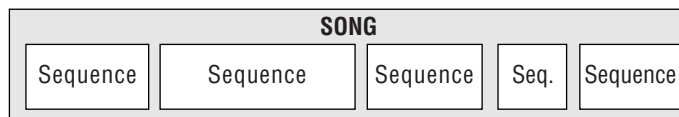

There are 64 tracks in a sequence to which individual performances can be recorded to. For example, track 1 could be the piano, track 2 could be the bass, and track 3 the organ. Normally, each track is recorded one at a time.

It is also possible to record a new track while playing previously recorded tracks. Each track can be turned on or off individually.

You can record different piano solos to track 1 and track 2 and compare the combination with the other tracks.

You can select either a Drum track or MIDI track. The drum track plays the recorded data of the internal sampler. The MIDI track plays the sound of the external MIDI sound source connected to MIDI OUT.

In order for the sequencer to play external synthesizers, you must send the notes from the A/B MIDI channels (16 MIDI channels for each of the 2 MIDI output jacks). On the MPC2000XL, each track can be independently assigned to one of these 32 output MIDI channels.

Bar.Beat.Tick

The sequencer of the MPC2000XL divides the quarter note into 96 parts. Each one of these divisions is called a tick.

In many of the sequence editing screens it is necessary to enter the start and end of the region that you want to edit. This is done using the time field, containing a bar number, beat number and tick number.

001.01.00
Bar Beat Tick

To specify the range to be edited, select bar, beat or tick with the cursor and set the value with the DATA wheel. The edit range set in the time field starts at the time entered on the right and continues to one tick before the time entered on the right. Therefore, if the settings were 001.01.00 – 003.01.00 then you cannot edit an event entered at 003.01.00. Also when you are editing each bar, the First bar: field is the first bar and the Last bar: field will be the last bar edited. In this case, the bar set in the Last bar: field is included in the edit range. When the First bar: is set to one and the Last bar: to two, the data of the first and second bars will be edited.

Examples of Sequence Recordings

The MPC2000XL is a sequencer with an internal sampler. You can simply use it as a drum machine, or as a sequencer connected to a MIDI device.

It is also possible to set a loop to a sequence and repeatedly play a phrase.

Example 1: Recording a Drum Pad Performance

First let's record a drum pad performance. This is the most basic use of the MPC2000XL, by using it simply as a rhythm machine.

1. Turn the power on and load the drum sounds from the enclosed sound disk. (Refer to the chapter "Loading and Playing Programs" for details on how to load the sounds.) When you have finished, check to see if the drum sounds can be played back by playing the drum pads.
2. Press MAIN SCREEN and display the Main Screen. The recording and play back of a sequence will always be done here.

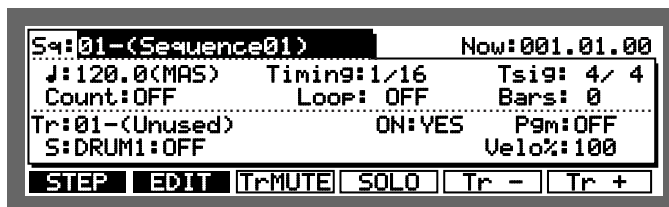

3. Select the S# field with the CURSOR keys and rotate the DATA wheel and select an unused sequence (Unused).
4. Select the field to the right of S# with the CURSOR key and rotate the DATA wheel to the right to select Drum 1.

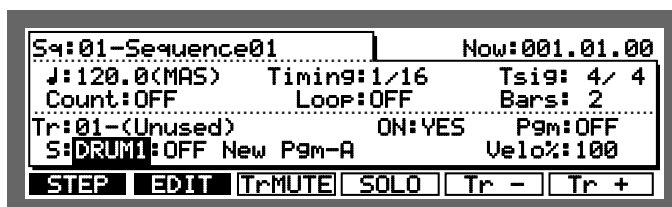

5. To set the number of bars for recording, select the Bars# field with the CURSOR keys and turn the DATA wheel to display the following screen. Select the number of bars with the DATA wheel and press DO IT [F5]

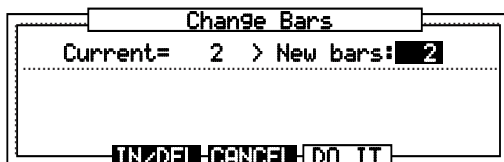

6. Select the **LOOP** field with the CURSOR keys and rotate the DATA wheel to the left to select **OFF**.

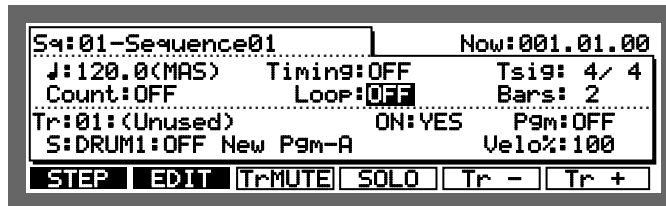

7. Select the **Count** field with the CURSOR keys and rotate the DATA wheel to the right to turn it **ON**.

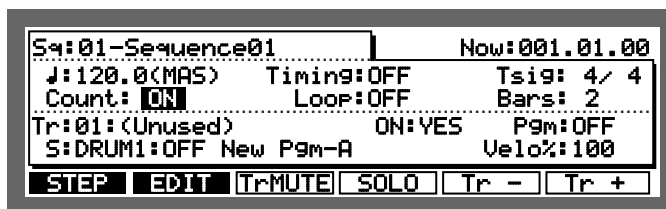

8. While still on the **Count** field, press OPEN WINDOW to open the Count/Metronome window.



9. Select the **Count in** field with the CURSOR keys and select **REC ONLY** with the DATA WHEEL. Then, select the **In rec** field and rotate the DATA wheel to the right and set it to **YES**.

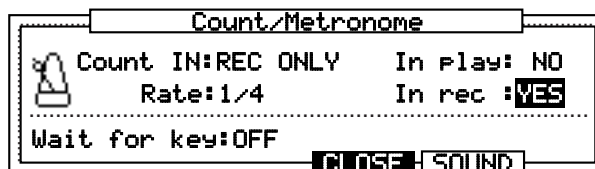

10. Press **SOUND** [F5] and select a metronome sound (**CLICK**, **DRUM 1**, **2**, **3** or **4**).
 - If you select **CLICK**, select and adjust the **Volume** level and **Output** (where the sound will be output from).
 - If you select **DRUM 1**, **2**, **3** or **4**, you can select 2 drum sounds (**Accent** and **Normal**) that will play as the metronome sound. You can select the sounds by pressing one of the drum pads or selecting the sound in the corresponding field. Then move to and adjust the velocity level of the sounds.
11. Press **CLOSE** [F4] twice to return to the Main Screen.
12. Hold down **REC** and press **PLAY START** to start recording. After a one bar count, recording will start and the bar.beat.tick numbers in the **Now** field will start to increase. Play the drum pads to the click or drum sounds.
13. Bars will automatically be added when the number of bars set in step 5 is exceeded. To stop in the middle of a recording, press **STOP**. You can play back the recorded sequence by pressing the **PLAY START** key.

14. Hold down REC and press PLAY START if you want to record over the previous recording.
15. To overdub on top of a recorded sequence, hold down OVER DUB and press PLAY START (the original recording is kept and the new sounds added to it).

Example 2: Recording a Loop

This allows you to repeatedly play a preset number of bars and keep dubbing sounds over it.

1. Turn the power on and load the drum sounds from the enclosed sound disk. (Refer to the chapter "Loading and Playing Programs" for details on how to load the sounds.) When you have finished, check to see if the drum sounds can be played back by playing the drum pads.
2. Press MAIN SCREEN and display the Main Screen. The recording and playback of a sequence will always be done here.



3. Select the S# field with the CURSOR keys and rotate the DATA wheel and select an unused sequence (Unused).
4. Select the track type field (S:) with the CURSOR key and rotate the DATA wheel to the right to select Drum 1.

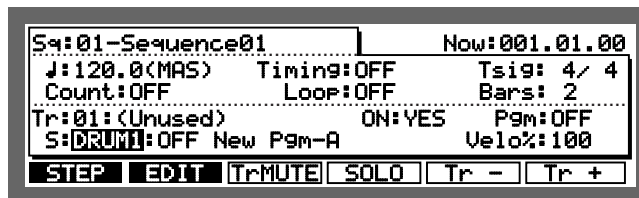

5. Select the Bars# field with the CURSOR keys and turn the DATA wheel to display the bar setting window. In this example, we will create a two-bar loop. Select "2" with the DATA wheel and press DO IT [F5].
If you record past the set number of bars, the sequence will return to the first bar.

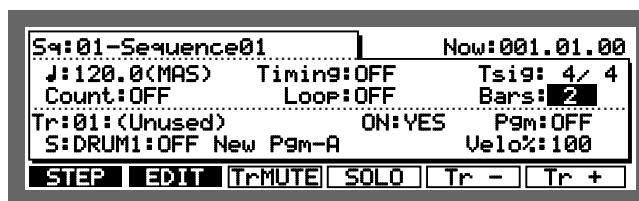

6. Select the LOOP# field with the CURSOR keys and rotate the DATA wheel to the right to turn it ON.

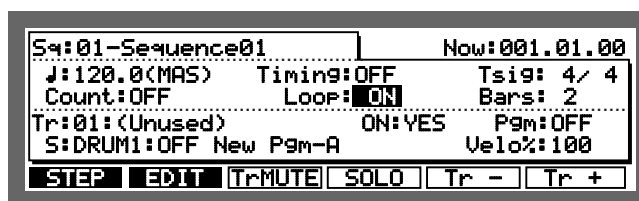

- While the **LOOP#** field is selected, press OPEN WINDOW to open the Loop window.

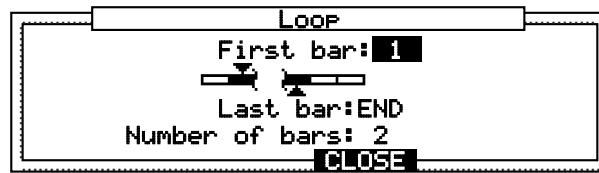

- Select the **First bar#** field with the CURSOR keys and set to 1 with the DATA wheel.
- Select the **Last bar#** field with the CURSOR keys and set to END with the DATA wheel. Close the Loop window by pressing **CLOSE** [F4].
- Select the **Count#** field with the CURSOR keys and rotate the DATA wheel to the right to turn it ON.



- While the **Count#** field is selected, press OPEN WINDOW to open the Count/Metronome window.

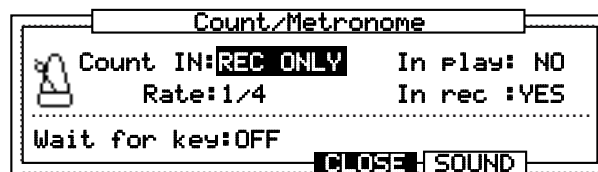

- Select the **Count in#** field with the CURSOR keys and select **REC ONLY** with the DATA wheel. Also select the **In rec#** field and set to **YES** by rotating the DATA wheel to the right.

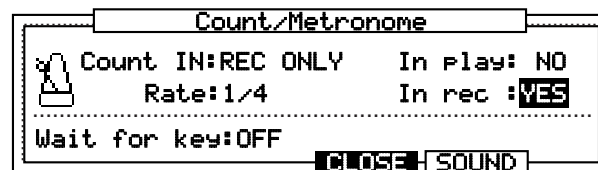

- Press **CLOSE** [F4] to close the Count/Metronome window and return to the main window.
- Start recording by holding down **REC** and pressing **OVER DUB**. After a one bar count, recording will start and the bar.beat.tick numbers in the **Now#** field will start to increase. Play the drum pads to the click or drum sounds. When the two bars have been recorded, the numbers will automatically return to the first bar and you can keep overdubbing as the bars loop.
- To finish recording, press **STOP**. You can play back the loop by pressing **PLAY START**. If you want to delete the recording, press **UNDO SEQ** and you can start again (see page 5 No. 10 for full explanation of this key).

Example 3: Recording with External MIDI Equipment

This is an example of recording using the internal sequencer and an external MIDI sound source in addition to the internal drum sounds.

1. Refer to the example on page 12 and connect the MIDI device to the MPC2000XL, turn the power on and load the drum sounds from the attached sound disk. (Refer to the chapter "Loading and Playing Programs" for details on how to load the sounds.) When you have finished loading, check to see if the drum sounds can be played back by playing the drum pads.
2. Use the drum pads to record the drum sounds in the same manner as shown in Example 1.
3. Select the Tr # field with the cursor and select a track which is not being used by rotating the DATA wheel to the right.

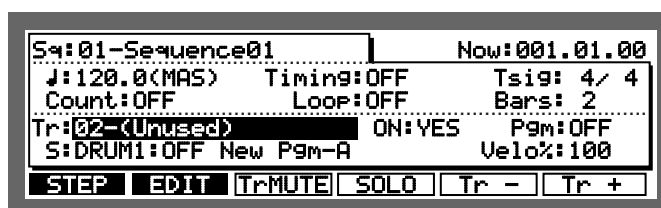

4. Select the Track Type field with the cursor and select MIDI by rotating the DATA wheel to the left.

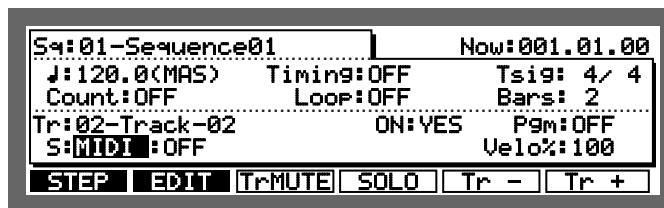

5. Select the MIDI Channel field with the cursor and set the MIDI channel of the MIDI device with the DATA wheel. As the MPC2000XL's receiving channel is normally set to OMNI, the keyboard's MIDI send channel can be set to any channel. As there are 2 MIDI outputs, you have the choice of selecting channels 1-16A or 1-16B, depending on which output your device is connected to. Once selected, play the keyboard and make sure that the sounds can be heard.

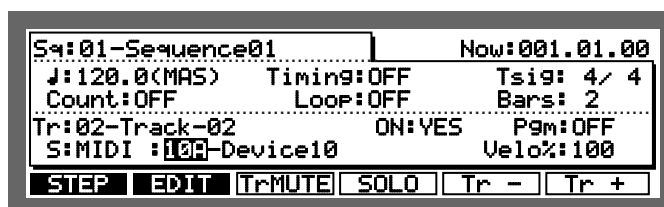

6. Start recording by pressing PLAY START while holding down REC. After one bar count, recording will start and the bar.beat.tick numbers in the Now # field will start to increase. Play the MIDI device to the prerecorded drum sound.

7. When the set number of bars is exceeded, bars will automatically be added. To stop the recording, press STOP. You can play back the sequence by pressing PLAY START.
8. To record again, hold down REC and press PLAY START.
9. Repeat steps 3 to 8 to overdub the external MIDI device sound.

The MAIN SCREEN

After the power is turned on, the LCD screen shows the following contents:

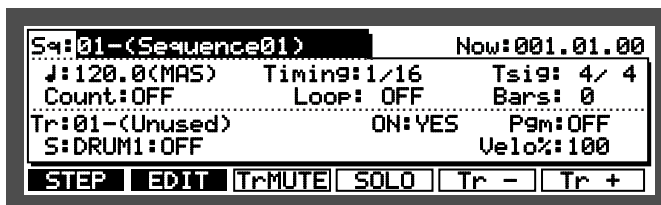

This is called the Main screen. It is the main operating screen of the MPC2000XL and most playing and recording of sequences is done while this screen is showing. To return to this screen, press the MAIN SCREEN key. The following is an explanation of each of the data fields and function keys contained in this screen:

Selecting a Sequence



Move the cursor to the S# field and turn the DATA wheel to select the sequence. The sequence number and sequence name will appear. (Unused) will appear when there is no data recorded to the sequence.

Renaming a Sequence

To open the Sequence window select the S# field and press OPEN WINDOW.

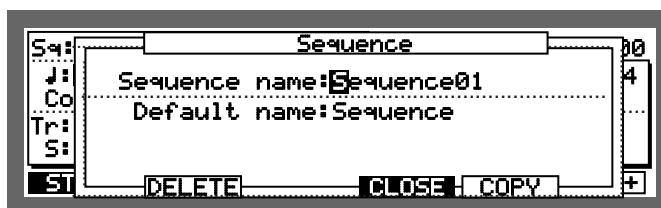

- **Sequence name:**
To change the name of the sequence.
- **Default name:**
When you are recording a new sequence, the name set here will automatically be used. When a name is actually used for a sequence, the sequence number will be added after the name. For example, if the default name is set to "Sequence", the name will be "Sequence01" (01 is the sequence number).

Name window

Tap a drum pad or rotate the DATA wheel at the name field to display the Name window. The Name window is common to all naming fields.

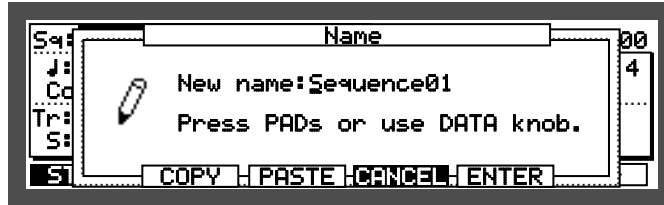

Enter letters with the DATA wheel and move to the left/right with the CURSOR LEFT or RIGHT keys.

You can directly enter letters from the drum pads. The letter shown on the top right of the pad will be entered when the pad is pressed. For example, A will be entered if you press PAD 1 once and B if you press it again.

Press 16 LEVELS to enter a space.

To switch between lower and upper case letters, press FULL LEVEL.

COPY [F2] copies the name to the clipboard and PASTE [F3] pastes the name from the clipboard.

Enter the name and press the ENTER [F5] key to confirm.

Deleting a Sequence

To open the Sequence window select the Seq# field and press OPEN WINDOW.

Press DELETE [F2].

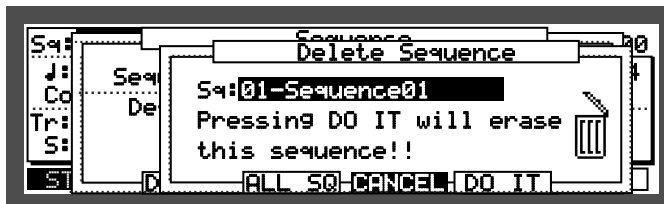

The selected sequence data will be erased if you press DO IT [F5] and the sequence name will change to (Unused).

The following warning will appear if you press ALL SQ [F3] and all of the sequence data will be erased when you press DO IT [F5].

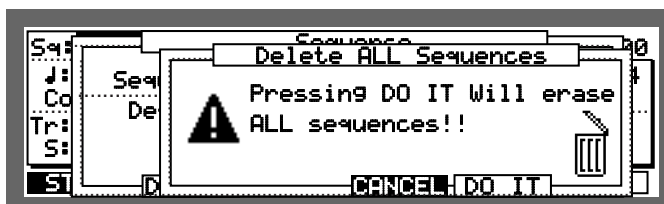

Copying a Sequence

To open the Sequence window select the **S#** field and press OPEN WINDOW.

Press COPY [F5] to open the Copy Sequence window.

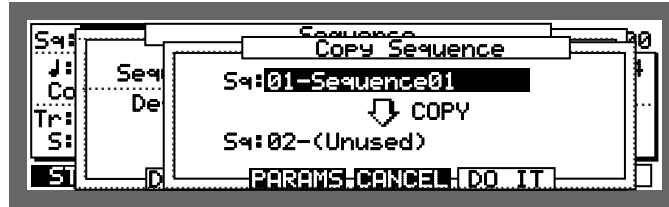

Select the sequence that you want to copy (top level) by pressing CURSOR UP and select the sequence with the DATA wheel.

Select the copy destination (bottom level) by pressing CURSOR DOWN and select the sequence you want to copy the data to with the DATA wheel.

The sequence data will be copied when you press DO IT [F5].

CAUTION: If there is data in the sequence you have selected as the destination, the data will be erased when you press DO IT. Be careful when you are copying to a sequence with a name other than "Unused."

When PARAMS [F3] is pressed, only the parameters will be copied to the selected sequence. The sequence data will not be copied.

Next sequence function

When the cursor is in the **S#** field while a sequence is playing, you can select the sequence to play next by rotating the DATA wheel. The following window appears when you rotate the DATA wheel.



Pressing the NEXT SEQ key shows the following screen.

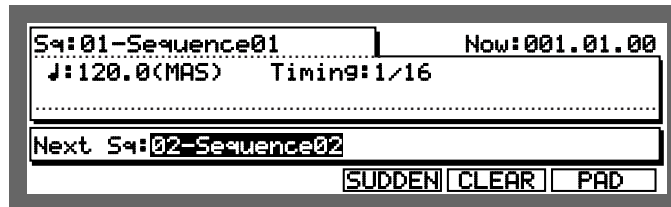

Select the sequence with the DATA wheel. In the above illustration, 02-Sequence02 is played back after 01-Sequence01 is played to the end. It is possible to play sequences consecutively in this manner. To stop the Next Sequence function select the number originally selected (the currently playing sequence in the Next **S#** field) or press CLEAR [F5] to clear the entry.

S# field

During the stop mode, the sequence that will be played back when the play key is pressed is displayed.

During the playback mode, the sequence being played back is displayed.

Next Seq# field

The sequence that will be played next is displayed.

SUDDEN [F4] key

The currently playing sequence will stop playing and the next sequence will immediately be played.

CLEAR [F5]

Empties the data in the Next Seq# field. If the Next Seq# field is empty, and the sequence playing is set to loop on, that sequence will be continuously looped until a separate sequence is input to Next Seq# or the STOP key is pressed.

PAD [F6]

Opens the pad window which shows you which sequences are assigned to which drum pads. This allows you to select the next sequence by pressing the relevant drum pads.

Selecting the Next Sequence with the Drum Pads

The pad screen shows you which sequences are assigned to which drum pads (sequences 1-64 correspond to drum pads A1-D16). This allows you to select the next sequence by pressing a drum pad (the first eight letters of the sequence name will be displayed).

Note: You can not select sequences 65-99 with the drum pads.

From the Next Sequence screen, press PAD [F6], the following screen appears.

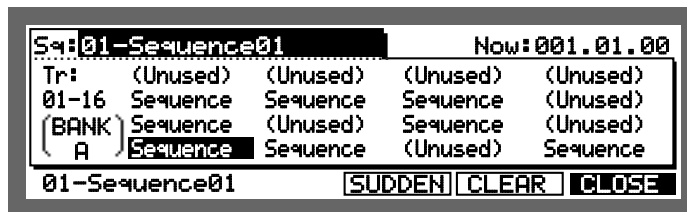

SUDDEN [F4]

During playback, press this key to start playback of the selected next sequence without waiting for the current one to finish.

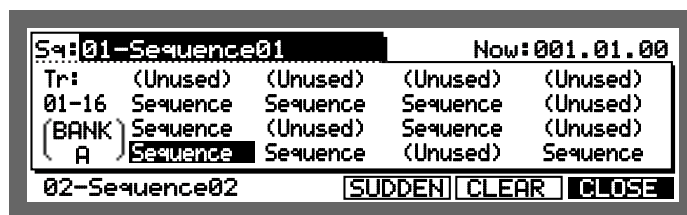

CLEAR [F5]

The sequence shown in the bottom left of the screen will be cancelled and the one selected in the Seq# field will be played.

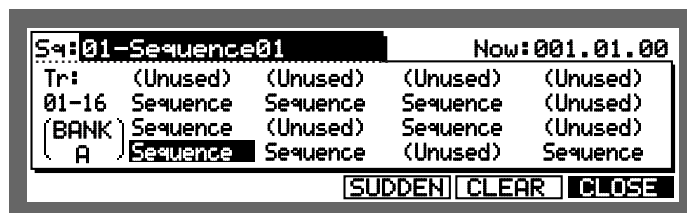

CLOSE [F6]

The screen will return to the previous "next sequence" display.

Second sequence feature

This allows you to play back two sequences at the same time: the sequence already selected on the main screen, plus another one that you can select here.

From the main screen, hold down SHIFT and press MISC. (numeric key 2), then press 2ndSEQ [F3].

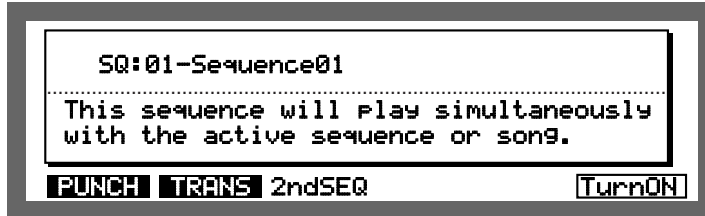

Using the DATA wheel, select the sequence that you want to play alongside the sequence already selected on the main screen and press Turn ON [F6].

The main screen will reappear and 2nd will be displayed to the left of the Now# field.

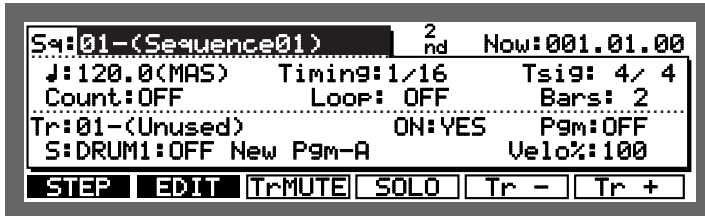

To cancel second sequence playback, go back to the Second Sequence screen and press OFF [F6].

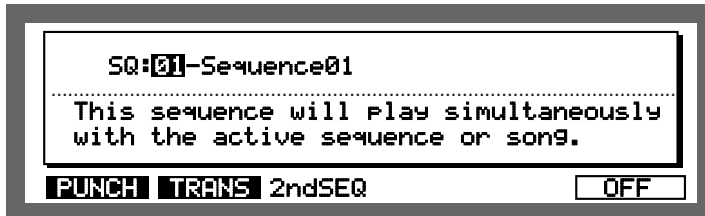

Setting the Tempo

To set the tempo of the sequence.

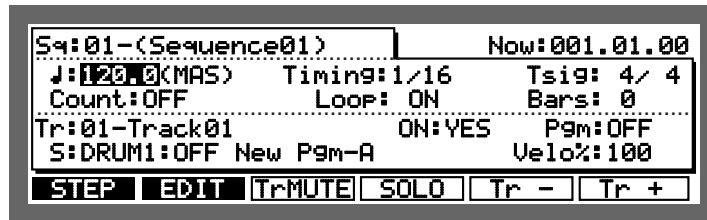

Move the cursor to the \downarrow field and set the tempo by rotating the DATA wheel.

To set the value to 120.5, enter "1205" and press ENTER. To set the value to 88.5, enter "885" and press ENTER to confirm the entry.

Note: If you do not press the ENTER key and move to other fields or pages, the entered data will be ignored and the tempo will not change.

Tempo Change Window

While still on the \downarrow tempo field, press OPEN WINDOW.

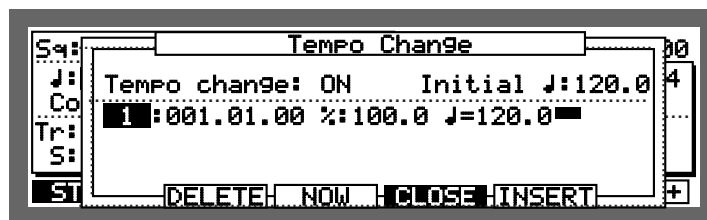

- **Tempo Change:**
Set the tempo change ON or OFF.
- **Initial \downarrow :**
This is the original tempo which is used as the base for tempo calculation.
- **1# (bar.beat.tick)**
Bar.beat.tick tempo change events are inserted here. The default tempo change is located at the beginning of the sequence. This can not be erased.
- **%#**
Set the tempo change event to a ratio of the original sequence tempo set in the Main Screen.
- **\downarrow #**
Set the tempo change event using an absolute value (for example 100.0 bpm).

CAUTION: The %# and the \downarrow # affect each other and the value of either will automatically change when a value is entered to one of the two.

Entering and Modifying a Tempo Change

To open the Tempo Change window, select the tempo field in the Main Screen and press OPEN WINDOW.

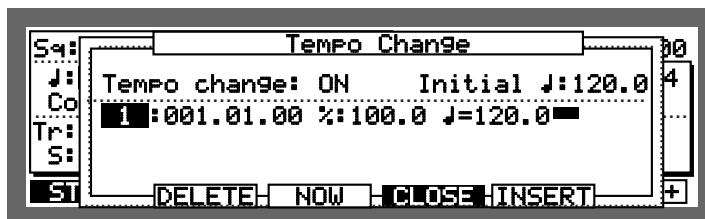

To insert the tempo change event, press INSERT [F5] and select the bar.beat.tick field and then set the tempo change event point, and set the tempo with %: or J: . Press NOW [F3] to input the current point as the Tempo Change event point.

The %: and J: work together, so if you change the value of one, the other will change correspondingly.

To make changes to the Tempo Change events, move the cursor to the event field that you want to change and change the various settings.

Note: When you are changing the tempo change event by selecting the bar.beat.tick field when multiple tempo change events are entered, you cannot set an event time beyond the area directly before or after the data you are trying to change. For example, if there is a tempo change event at points 002.01.00, 003.01.00 and 004.01.00, it is not possible to change the data before 002.01.00 or after 004.01.00 when you are changing 003.01.00.

When there are many tempo change events entered, it is possible to scroll the screen with the CURSOR UP or DOWN keys.

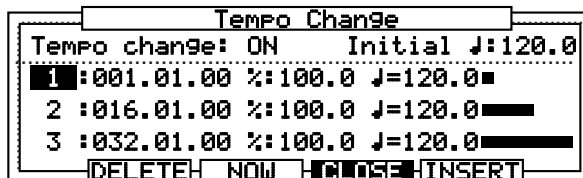

To delete the tempo change event, select the tempo change event you want to delete with the CURSOR UP or DOWN key and press DELETE [F2].

A lower case c will be displayed in front of the tempo field J: on the main screen when Tempo Change is ON and the tempo has been changed from the original set tempo by Tempo Change event.

Note: The initial tempo is the basis of the tempo in the sequence. When Tempo Change is set to OFF, the tempo field value and the initial tempo are the same. When Tempo Change is set to ON, the value of the tempo field in the Main Screen shows the tempo changed according to the Tempo Change event.

Selecting a Tempo Source

This allows the performance of each sequence to a set tempo or the master tempo set by MPC 2000XL.

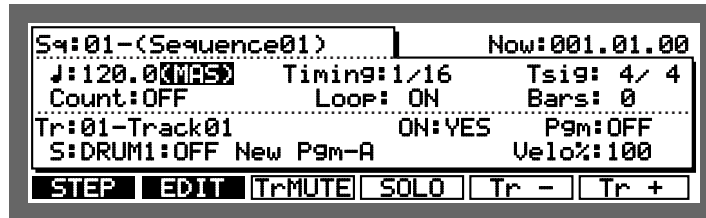

Move the cursor to the Tempo Source Field as shown above and set the tempo source with the DATA wheel.

- **(SEQ)**
Each sequence that you play back may have a different tempo. When **(SEQ)** is selected, the sequence's tempo is displayed in the Tempo field. It is possible to set this tempo for each sequence individually. When playing sequences, this is useful if you want each sequence to play at its preset tempo. The sequence's tempo is saved to disk along with sequence data when a sequence is saved.
- **(MAS)**
The master tempo is a single tempo setting that applies to all sequences and songs. When playing sequences this is useful if you always want each selected sequence to play at the same tempo. This can be especially useful in the "Next sequence" mode, where following sequences may have different tempos and you want them to all play at the same tempo. This tempo setting is not saved in the sequence file.

Setting the Time Correct (Quantization)

When data is recorded to a sequence in real-time, the note event is time corrected to the value specified here.

Also, when the bar, beat, or tick point is moved using the STEP </> key, the value specified here is used.

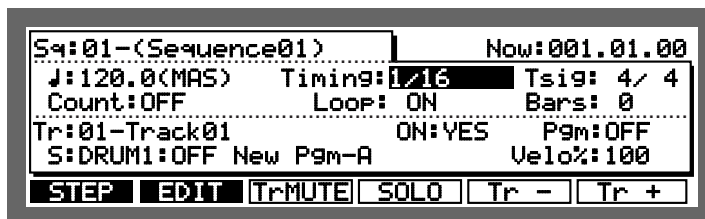

Select the Timing: field with the CURSOR and set the quantize rate by rotating the DATA wheel. The options are as follows:

- OFF No timing correction. Moves the point by one tick each time the STEP </> key is pressed.
- 1/8 All notes are moved to the nearest 1/8-note (48 tick).
- 1/8(3) All notes are moved to the nearest 1/8-note triplet (32 tick).
- 1/16 All notes are moved to the nearest 1/16-note (24 tick).
- 1/16(3) All notes are moved to the nearest 1/16-note triplet (16 tick).
- 1/32 All notes are moved to the nearest 1/32-note (12 tick).
- 1/32(3) All notes are moved to the nearest 1/32-note triplet (8 tick).

It is also possible to make fine adjustments in the following Time Correction window.

CAUTION: Timing Correct is only valid for note events. Control Change or Pitch Bend will not be time corrected.

To make fine adjustments in the Time Correct window, select the Timing: field with the CURSOR key and press the OPEN WINDOW key.

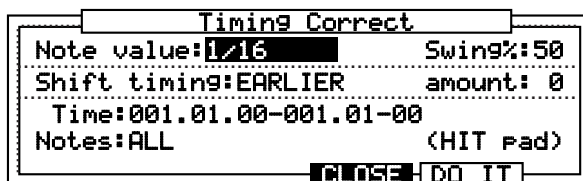

To time correct recorded data, set the following fields and press DO IT[F5]. Only the track selected on the main screen will be time corrected.

- Note Value: This is the same as the Timing: field on the Main Screen.
- Swing %: This appears only when Note Value: is set to 1/8 or 1/16. Shift the note events of the even beats at the ratio set here to add a swing to the rhythm.
- Shift Timing: This shifts the note event back or forward the number of ticks set in the amount: field below.
 - EARLIER shifts forward
 - LATER shifts back

- **amount:**
This sets the amount of the shift timing. The maximum value varies depending on the Note Value settings. For example, if the Note Value is set at 1/16, the maximum amount is 12 which corresponds to half of the time correction value (24 ticks).
- **Time:**
This sets the data range of the recorded data when the timing is corrected. The timing of any data not specified within this range will not be corrected. For the Drum Track, select the drum by tapping a drum pad.
- **Notes:**
For MIDI tracks, this sets the note range of the recorded data when the timing is corrected. The timing of notes not specified within this range will not be corrected. In the case of drum tracks, make selection by tapping the pads.
- **DO IT [F5]**
Pressing this key executes the quantization changes to the sequence.

Setting the Beat

The **Tsig:** field shows the beat of the sequence in the **Now:** time field (in this example, 4 beats to a bar).

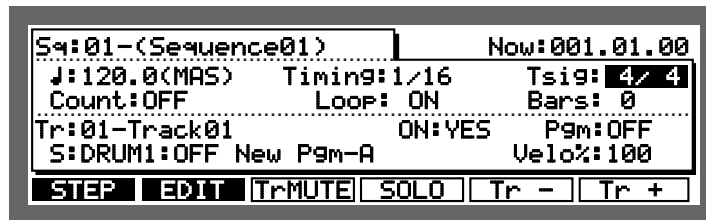

Select the **Tsig:** field with the CURSOR and rotate the DATA wheel to display the Change Tsig window.

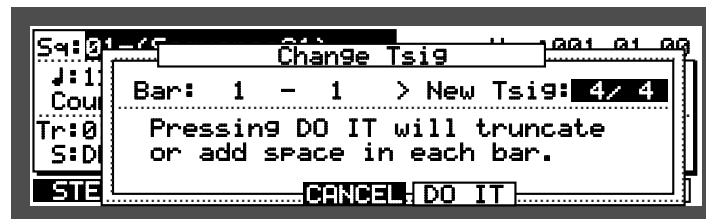

In the **Bar:** field, set the range of bars in which the beat will be changed with the CURSOR keys and the DATA wheel. In the **New Tsig:** field, select the new beat.

If the beat is set in the **New Tsig:** field to extend the bar (i.e. 5/4), a blank space will appear at the end of each bar.

If the bar is shortened (i.e. 4/4 shortened to 3/4), the end of each bar is cut. Press **DO IT [F5]** to execute the beat setting.

You can also display the Change Tsig window by pressing the OPEN WINDOW key when you are in the **Tsig:** field.

Setting the Number of Bars

To set the number of bars for each sequence.

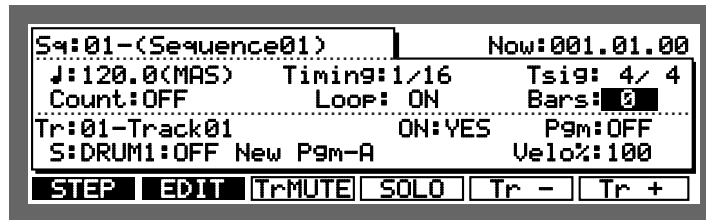

To display the Change Bars window select the Bars: field with the CURSOR and rotate the DATA wheel.

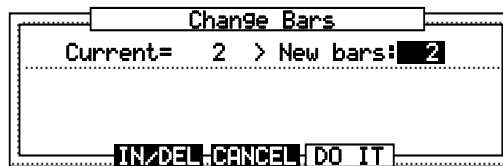

Continue to rotate the DATA wheel to set the number of bars.

When the number of bars is increased, the message “The end of the sequence will have blank bars,” will appear. Press DO IT[F5] to execute the change.

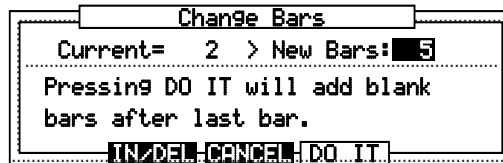

When the number of bars is decreased, the warning, “Pressing DO IT will truncate last bars” will appear. Press DO IT[F5] to execute the change.

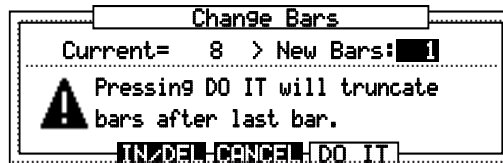

To insert or delete bars in the middle of the sequence, press the IN/DEL[F3] key.

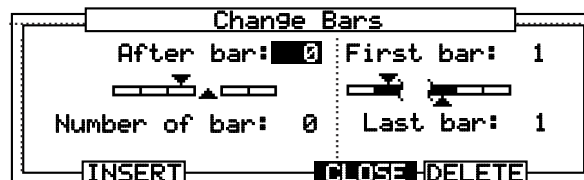

This window is divided into two functions. The left side is for inserting and the right side is for deleting bars.

Both fields function independently. To insert, set the left side and press INSERT [F2]. A blank bar(s) is inserted in the sequence. To delete, set the right side and press DELETE [F5]. A bar(s) in the sequence will be deleted.

The following is a description of each field.

- **After bar:**
Specifies where to insert a bar. The new blank bar is inserted after the specified bar.
- **Number of bars:**
Specifies the number of bars to insert.
To insert a bar, press **INSERT[F2]** after completing the above settings.
- **First bar:**
Specify the beginning of the bar(s) to delete.
- **Last bar:**
Specify the end of the bar(s) to delete.

To delete the bar(s), press **DELETE[F5]** after completing the above settings.

Looping a Sequence

During playback, the designated region of the sequence will be played back repeatedly until STOP is pressed. During recording, after the set number of bars have been recorded the REC mode automatically changes to the OVERDUB mode and the sequence will then play repeatedly until STOP is pressed, allowing you to keep dubbing on top of the sequence (further recording is added to the original, the original is not deleted).

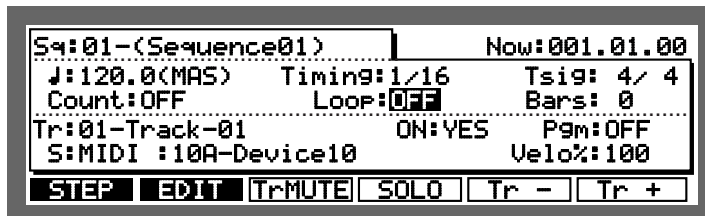

To set the loop ON or OFF, select the **LOOP #** field with the CURSOR keys and rotate the DATA wheel.

To set the range of the loop, press the OPEN WINDOW key.

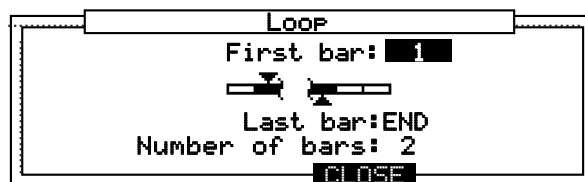

- **First bar#**
Specifies the first bar of the loop.
- **Last bar#**
Specifies the last bar of the loop. In this field, you can also select the **END** so that the last bar of the sequence is set as the Last bar: even if you change the number of bars in a sequence in the Main Screen **Bars#** field.
- **Number of bars#**
This sets the range of the loop by the number of bars. The number of bars that loop will be from the bar set in **First bar#** to the number of bars set here.

CAUTION: *First bar# and the Number of bars# as well as the Last bar# and the Number of bars# affect each other. If you change the First bar# or Last bar#, the value of Number of bars# will change accordingly. Also, by changing the Number of bars#, the value of Last bar# will change accordingly.*

Setting the Recording Count In / Metronome

This is for set-up of the count in and metronome.

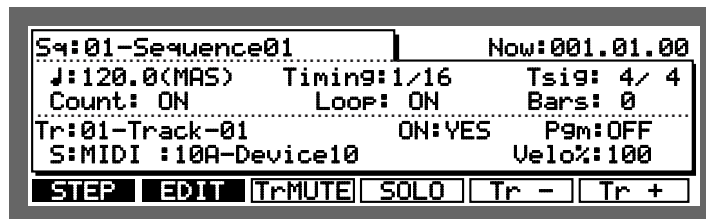

Select the **Count#** field with the CURSOR key and select ON or OFF by rotating the DATA wheel. To adjust the count in preferences, press the OPEN WINDOW key and open the Count/Metronome window.

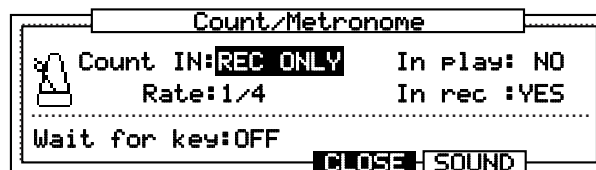

- **Count IN#**
This sets the count in before recording begins.

OFF	Will not count in.
REC+PLAY	Counts in before recording and playing.
REC ONLY	Counts in only before recording.
- **In play#**
This turns the metronome sound on (YES) or off (NO) while you are playing a sequence.
- **In rec#**
This turns the metronome sound on (YES) or off (NO) while you are recording a sequence.
- **Rate#**
This sets the note value of the metronome. For example, to play at quarter notes, set it to 1/4 and for eighth notes to 1/8.
- **Wait for key#**
Set this ON to start a sequence recording with MIDI signals from external devices such as MIDI keyboards.
When the Wait for key: is on, recording will not start when you press the REC and PLAY keys, but will be in the stand-by mode. Recording starts when the MPC2000XL receives a MIDI signal from an external MIDI keyboard. In this case, the first MIDI signal received to start recording will not be recorded.
This is convenient when the MPC2000XL and the MIDI keyboard are not located close together during recording.

Setting the metronome sound, volume and output

When the “Count/Metronome” window is displayed (see previous section), pressing “SOUND” (F5) opens the “Metronome sound” window where you can select sounds and output for the metronome.

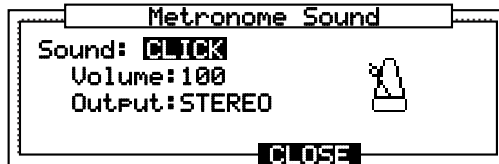

Sound:

Here you can select a metronome sound **CLICK**, **DRUM 1**, **2**, **3** or **4**.

By selecting **DRUM 1-4**, the metronome function can be used using the internal drum sounds. If **CLICK** is selected, the following will be displayed.

Volume:

This sets the volume level of the metronome.

Output:

This sets where the sound of the metronome will be output from:

STEREO, from the **STEREO OUT/HEADPHONE** jacks.

OUT 1 - 8, from the optional **ASSIGNABLE MIX OUT** jacks.

If you select **DRUM1**, **2**, **3** or **4** in the **Sound:** field, you can select 2 drum sounds (**Accent** and **Normal**) that will play as the metronome sound. You can select the sounds by pressing one of the drum pads or selecting the sound in the corresponding field.

The velocity level of the sounds can be adjusted in the **Velocity:** fields.

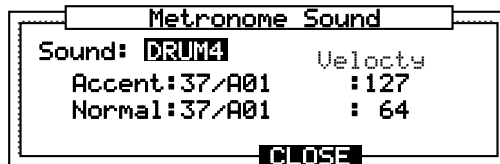

Selecting a Track

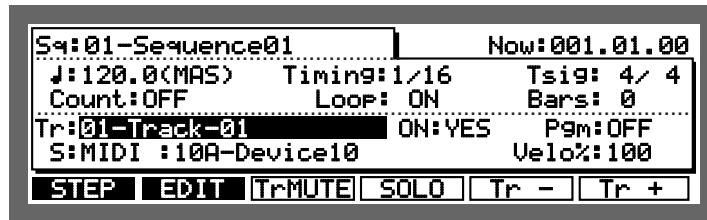

Move the cursor to the Tr #: field and select the track by rotating the DATA wheel. The name and number of each track will appear.

Renaming a Track

To open the Track window, select the Tr #: field and press the OPEN WINDOW key.



- **Track name:**
This changes the name of the track.
The name window will be displayed by turning the DATA wheel or tapping a pad.

Press ENTER to save the name.

Note: If you do not press the ENTER key and move the Default field or other pages with the CURSOR DOWN key, the entered name will be ignored and the name will not be changed.

- **Default:**
You can use this as the default name for each track (instead of Track). Enter the name in the same way as the Track name.

Deleting a Track

From the Main Screen, select the Tr#: field and press OPEN WINDOW.

To open the Delete Track window, press DELETE [F2].

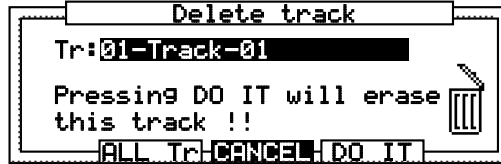

To erase the data of the selected track, press DO IT [F5].

When you press ALL Tr [F3], the following warning will appear and all track data will be erased when DO IT [F5] is pressed.

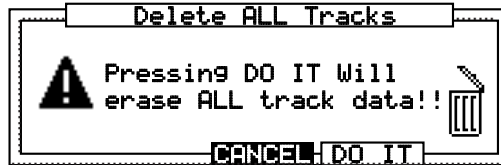

Copying a Track

From the Main Screen, select the Tr#: field and press OPEN WINDOW.

To open the Copy Track window, press COPY [F5].

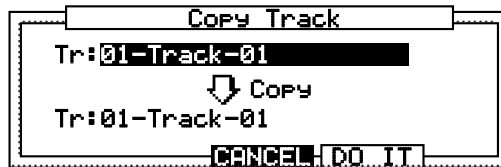

Select the upper field by pressing the CURSOR UP key and select the track you want to copy with the DATA wheel.

Select the lower field by pressing the CURSOR DOWN key and select the track that you want to copy the data to with the the DATA wheel.

CAUTION: If there is data in the track that you have selected as the destination track, that data will be erased and replaced with the new track.

To copy the data, press DO IT [F5].

Turning the Track ON or OFF

Press the TrMUTE [F3] key to turn the track on (YES) or off (NO) (the present condition is displayed in the On# field). It can also be turned off by moving the cursor to this field and rotating the DATA wheel.

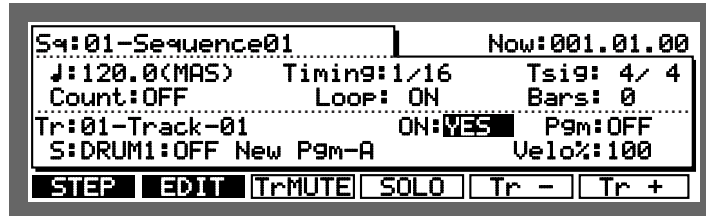

Turning tracks on or off with the drum pads

From the MAIN SCREEN, press TRACK MUTE, the indicator lights and the following screen will appear.

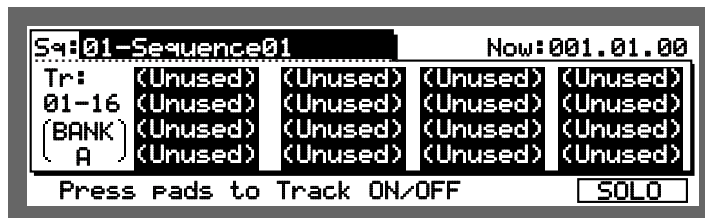

You can mute tracks by selecting one of the PAD BANKS: A (tracks 1-16), B (tracks 17-32), C (tracks 33-48), D (tracks 49-64) and pressing the corresponding drum pad (pressing the pad again turns the track back on).

The screen above shows all 16 tracks are turned on. When a track is turned off, the surrounding blue field will disappear and the track name will be blue.

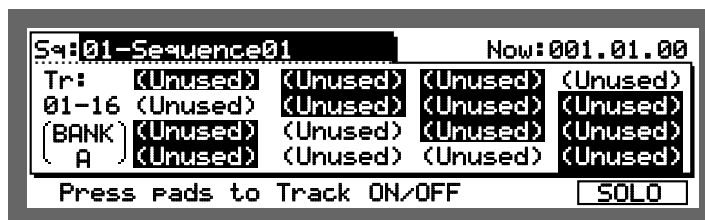

By holding the SOLO [F6] key down and pressing one of the drum pads, you can solo a track so that only that track will be turned on.

Press SOLO [F6] again to cancel the solo mode.

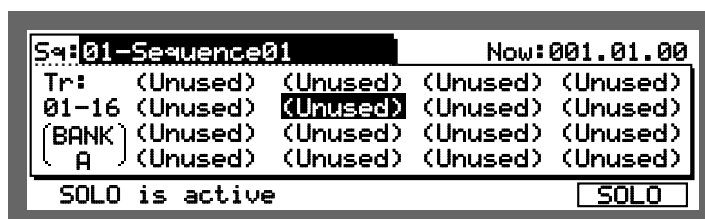

Press the TRACK MUTE key again return to the Main Screen.

Deleting All the Tracks that You Have Turned Off

To delete all of the tracks that have been turned off, move the cursor to the Main Screen **ON:** field.

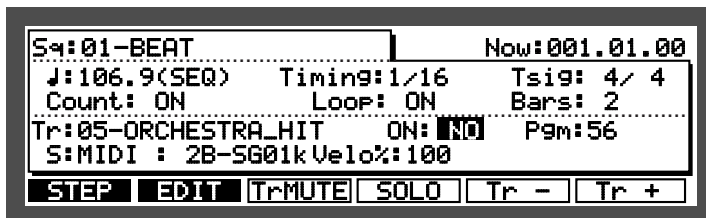

Press **OPEN WINDOW** to display the **Erase all OFF tracks** screen.

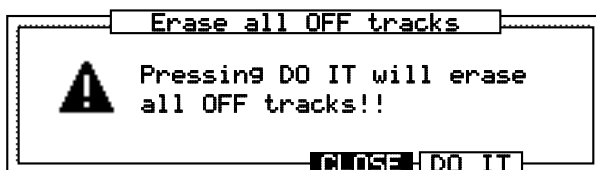

Press **DO IT [F5]** to delete all the off tracks and return to the Main Screen.

Setting the Track Type

This sets the track to either the sound source within MPC2000XL or other external MIDI devices.

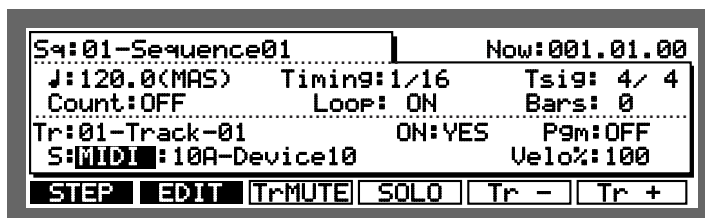

Select the field as shown above with the **CURSOR** keys and select between **MIDI** and **Drum 1 - 4** by rotating the **DATA** wheel.

- MIDI** Allows data input from devices such as MIDI keyboards and uses the track to play the sound source of external MIDI devices.
- Drum 1 - 4** Allows data input from **DRUMS PAD** and uses the track to play the internal sound source.
Because programs can be assigned individually to **DRUM 1-4**, the tracks can be assigned to different drum programs and up to 4 different programs can be played at the same time.

Settings for MIDI Reception

From the Main Screen, select the track type field (MIDI or Drum 1-4) and press the OPEN WINDOW key to display the MIDI input window.



- **Receive channel:**
Set the receiving MIDI channel. All the other data that has not been set to a MIDI channel is ignored. Set this to ALL to receive on all MIDI channels.
- **Prog change ▶ Seq:**
You can set whether sequences are changed with MIDI Program Change messages from an external MIDI device. When set to ON, Program Change messages will be received and the same sequence number as the MIDI Program Change number will be selected.
- **Sustain Pedal to Duration:**
When performances from devices such as a MIDI keyboard are recorded to the sequencer, the sustain pedal message (control number 64) is recorded with the note data, but the following issues arise.
 1. If you delete or erase a section of the sequence that contained a Sustain Off message, all notes after that location will be sustained until the next Sustain On message.
 2. When multiple tracks are set to the same MIDI channel and one track only contains sustain pedal data, the other track(s) set to the same MIDI channel will also have sustain effects.
 3. If you merge a track with sustain pedal information into a track without sustain pedal information, notes on the resultant track will be sustained.
 4. If you overdub notes into a track containing sustain pedal information, the new notes will be sustained.

The MPC2000XL solves these problems by specially processing sustain pedal messages. If the **Sustain pedal to Duration** field is set to ON, when the MPC2000XL receives a Sustain On message during record, it will NOT record it. Instead, it will be converted to Note ON/OFF data. As a result, the duration of the note on the recorded track becomes longer.

There are some situations in which converting sustain pedal to the duration of the note is undesirable:

1. Depending on the settings and specifications of the MIDI sound source when the duration of a note is too long and exceeds the number of voices that can be sounded, new notes may be ignored and may not generate a sound.
2. Depending on the settings of the MIDI sound source, MIDI control number 64 may be used for messages other than sustain.

In this case, by turning this field off, you can record a sustain pedal message (control number 64).

MIDI Filter Function

This sets the MPC2000XL to receive or not receive MIDI events.

- **MIDI filter#:**
This is the on or off setting for the entire MIDI filter function. When this is off, all MIDI events will be received regardless of the settings in the **Type#:** and **Pass?#:** fields.
- **Type#:**
Set the type of MIDI event - the following MIDI events can be filtered (for details on MIDI events, it is advisable to read a MIDI guide book).
NOTES, PITCH BEND, PROG(ram) CHANGE, CH(annel) PRESSURE, POLY PRESS(ure), EXCLUSIVE, CONTROL:ALL (All control changes, Control Change #000 ~ #127).
- **Pass?#:**
This sets the reception of a MIDI event selected in **Type#:**. Set this to YES to receive MIDI events set in **Type#:** and NO to ignore the events.

Pressing **MONITR [F2]** displays the MIDI input monitor, where you can monitor which MIDI channels are being received (the black squares above the MIDI channel numbers will flash).

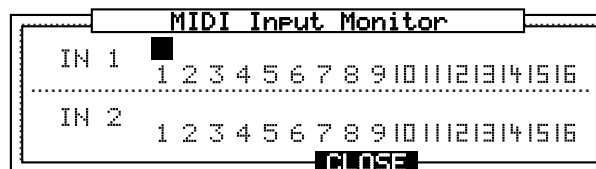

Setting the Track's MIDI Channel

This sets the MIDI output channel of the selected track.

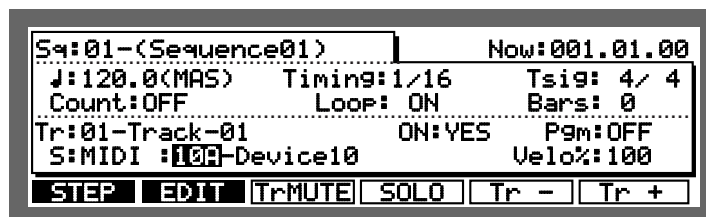

Select the field as shown above with the **CURSOR** keys and rotate the **DATA** wheel to select the MIDI output channel.

For example, in the setting shown above, the data of track 01 (which is currently selected) sends data from MIDI OUT A on MIDI channel 10.

Set the MIDI channel to correspond to the connected MIDI sound source. For example, if the MIDI channel of the external MIDI sound source you want to play is set to 5, you can use track data to play the MIDI sound source by setting the MIDI channel of the track to 5. The drum tracks are normally used to play the internal sampler, but if a MIDI channel is set it will output MIDI data from the selected channel. If you do not want to output the drum track data in MIDI format, set the MIDI channel to **OFF**.

Settings for MIDI output

To display the MIDI output window, from the Main Screen, select the field shown below.

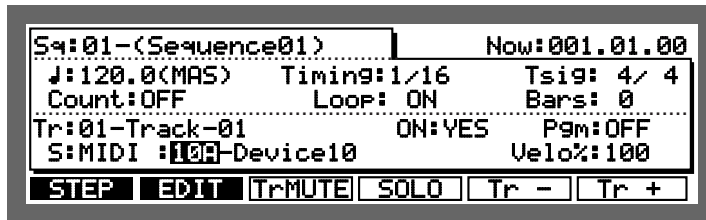

Then press OPEN WINDOW.



Soft thru:

To set the MIDI channel that MIDI data received at MIDI IN is to be sent out through MIDI OUT.

OFF

MIDI through is turned off.

AS TRACK

In single track recording mode, the MIDI OUT channel will be set according to the setting of each track.

In multiple track recording mode, the MIDI OUT signal will be sent out as specified in the Multi Recording Setup window.

OMNI-A

MIDI data received at MIDI IN will be sent out through MIDI OUT A. During track playback, this data will be merged with the track data.

OMNI-B

MIDI data received at MIDI IN will be sent out through MIDI OUT B.

OMNI-AB

MIDI data received at MIDI IN will be sent out through MIDI OUT A and B.

Device name:

You can name a MIDI device name here after selecting the MIDI channel (01A - 16B). This setting is common to all sequences.

Panic

This will stop all external MIDI devices from playing (All note off and Reset all controller messages are sent).

Pressing MONITR [F2] displays the MIDI output monitor, where you can monitor which MIDI channels are being sent (the black squares above the MIDI channel numbers will flash).

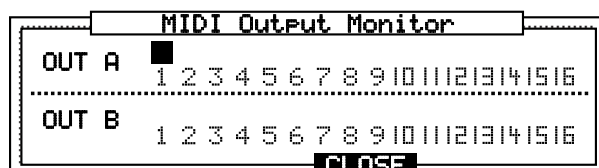

Multiple Track Recording

With this mode, multiple tracks can be recorded at the same time.

From the Main Screen (press MAIN SCREEN), move the cursor to the **S**: field.

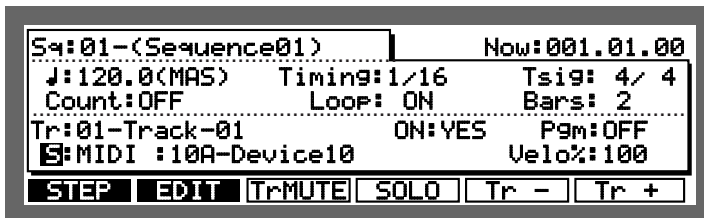

Here you can select **S** for single track recording or **M** for multiple track recording.

In single track recording mode, only the track currently selected in the Main Screen will be recorded. In the multiple track recording mode, a number of tracks can be recorded simultaneously.

If you selected multiple track recording, press OPEN WINDOW to display the **Multi Recording Setup** screen.



In (MIDI channel input)

Select the MIDI input channel with the CURSOR UP/DOWN keys.

Track

Select the track to be recorded to. If two or more of the MIDI inputs are set to the same track, MIDI data will be merged onto that track and recorded. Set the **Track** field to OFF if you do not want to record.

Out (MIDI channel output)

Select the track with the CURSOR UP/DOWN keys and enter the MIDI output channel with the DATA wheel. If two or more of the MIDI inputs are set to the same track, they will be merged and sent out.

To start recording, close the window and then hold REC and press PLAY.

Editing the Velocity

This adjusts the velocity of the data that is recorded on the selected track when the sequence is played.



Select the `Velo%` field with the CURSOR keys and set the incremental or decremental ratio of the velocity with the DATA wheel.

CAUTION: This setting will not directly edit the recorded data. The velocity will increase or decrease according to the ratio set here only during playback. Also, data with a maximum velocity (127) will not be affected by values set over 100%.

To edit the velocity of prerecorded data, use the Edit Velocity window.

To display the Edit Velocity window, select the `Velo%` field and press OPEN WINDOW.

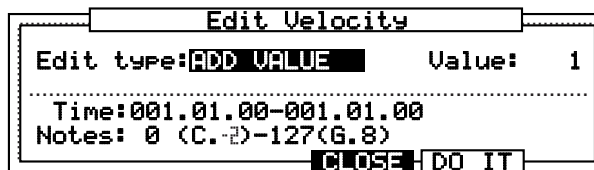

To directly change the velocity of recorded data, set the following fields and press DO IT[F5].

- `Edit type:`
Select the method of changing the velocity.
 - `ADD VALUE` Adds the set `Value:` to the current velocity.
 - `SUB VALUE` Subtracts the set `Value:` from the current velocity.
 - `MULT VAL%` Increases or decreases the set `Value:` ratio (percentage) against the current velocity.
 - `SET TO VAL` Sets all of the velocity values uniformly to the set `Value:`.
- `Value:`
Sets the value of the edit method selected in `Edit type:`.
- `Time:`
Specifies the data range to be edited when the velocity of the recorded data is edited. Any data not specified within this range will not be edited.
- `Notes:`
Specifies the note range to be edited on the MIDI track when the velocity of recorded data is edited. Any note not specified within this range will not be edited. On the Drum track, notes can be entered by pressing the drum pads.

Setting the Program Change Transfer

You can send program changes on each track in addition to sending program change events within a track when a sequence is selected.

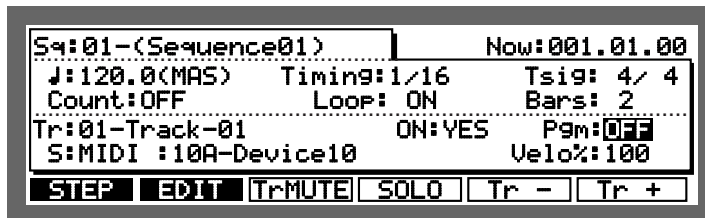

Select the **Pgm#** field with the CURSOR key and set the program number you want to set with the data wheel. The program change will not be sent if set to OFF.

To display the following window, select the **Pgm#** field and press OPEN WINDOW.

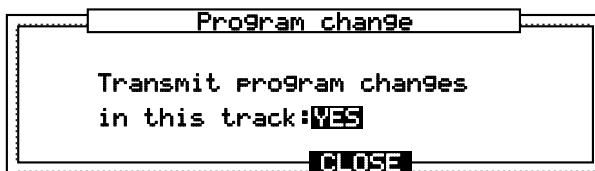

Set the field to enable (YES) or disable (NO) the transfer of program change recorded on the selected track. When this is set OFF, the program change will not be sent even if there is a program change on the track.

Locating with the DATA Wheel

You can locate a point in the sequence with the DATA wheel.

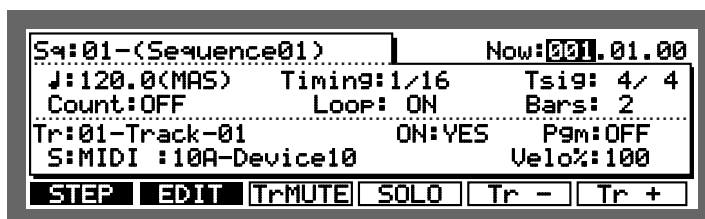

To locate, select the **Now#** field with the CURSOR keys and increase or decrease the number with the DATA wheel.

Units Used to Locate a Point

You can select bar/beat/clock or hours/minutes/seconds to be displayed in the **Now#** field.

Select the **Now#** field and press OPEN WINDOW.



- **Display style:**
Select `BAR`, `BEAT`, `CLOCK` to display bar, beat, and clock. Select `HOUR`, `MINUTE`, `SEC` to display the hours, minutes, and seconds.
- **Start time:**
Select `HOUR`, `MINUTE`, `SEC` in `Display style:` to start the time display on the main screen from the time set in this field. This can also be used as the start time to synchronize MTC (MIDI time code) or SMPTE time codes.
- **Frame rate:**
This sets the frame rate of the time code used to synchronize the MTC or SMPTE code. Synchronization is described in "MIDI/SYNC Mode".

The Main Screen Function Keys

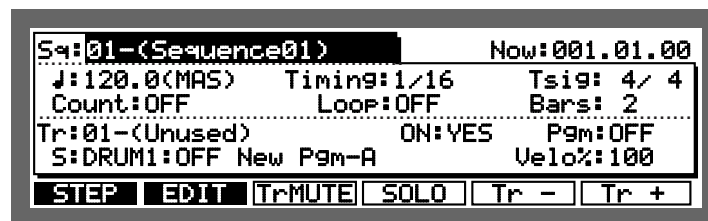

- **STEP**
This displays the step edit page which allows you to edit on sequence data at a time.
- **EDIT**
This edits or sets other elements of a sequence.
- **TrMUTE**
This turns the track on or off.
- **SOLO**
This enables you to play only the currently selected track. The `SOLO` display blinks when you press the key and enables solo playing. Press it again to turn it OFF, enabling all tracks to play.
- **Tr -** **Tr +**
Select the track with this function key. It is not necessary to move the cursor to the `Tr :` field.

The Play/Record Keys and the Locate Keys

These ten keys operate similarly to the transport keys on a tape recorder, with some useful additions:

- The PLAY START key:
This plays back the currently selected sequence to begin playing from the first bar.
- The PLAY key:
This plays back the sequence from the current position displayed in the **Now#** field on the Main Screen.
- The STOP key:
This stops playback or recording.
- The OVERDUB key:
While holding this key, press PLAY to overdub new notes to the track, without erasing existing notes. You can Overdub from the stop or playback modes.
While the Overdub mode is active, the light above the OVERDUB key is on.
To cancel the Overdub mode, press the OVERDUB key again and the light above the key will turn off.
- The REC key:
While holding this key, press PLAY to start recording. New notes can be recorded into the currently selected track while existing notes are erased, just as with a tape recorder.
You can record from the stop or playback modes.
During recording, the LED above the REC key is on.
To stop recording, press the RECORD key again and the light above the key will turn off.
- The BAR << / >> Keys:
By pressing one of these keys, you can move the sequence position back or forward by one bar. To move to the beginning of the sequence, hold down the GO TO key and press the BAR << key. To move to the end of the sequence, hold down the GO TO key and press the BAR >> key.
- The STEP < / > Keys:
By pressing one of these keys, you can move the sequence position back or forth by setting a number on the **Timing#** field on the Main Screen. For example, when the Timing is set to 1/16, you can move back 24 ticks every time you press STEP >. If you press this button while holding down the GO TO key, you can locate the position directly before or after an entered event.
- The GO TO Key:
This key is used to move to a specific position within the sequence. When pressed, the following screen is displayed:

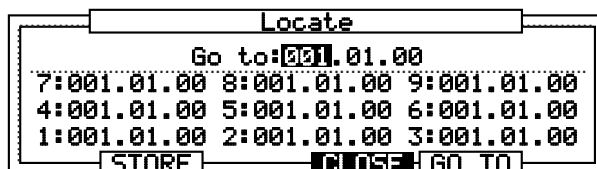

Go to:

When the window is opened, the time from the **Now#** display of the Main Screen is displayed here.

You can change the displayed time with the DATA wheel or input it directly with the numeric keys and then press GO TO to move to that location and return to the Main Screen.

Storing a locate point from the stop mode

Select a location point in the `Now#` field of the Main Screen and press the GO TO key. Select a locate memory (that you want to save) from 1 - 9 with the CURSOR keys.

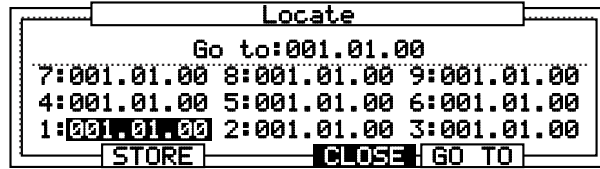

Press `STORE` [F2], the locate point is stored and the Main Screen will re-appear.

Moving to stored locate points

Press the `GO TO` key and select from locations 1 - 9 with the CURSOR keys. Then press `GO TO` [F5] to move to the selected location.

AUTO PUNCH IN / OUT

Auto Punch allows you to Overdub or Record automatically between 2 preset points. This can be very useful at times such as when you want to execute a very tight punch-in and there isn't enough time to get from the MPC2000XL to the MIDI keyboard to play the new notes after the punch-in. The Auto Punch function allows you to punch in automatically, allowing you to concentrate on your performance.

Hold SHIFT and press MISC. (2 on the numeric pad).



- **Auto punch:**
There are three auto punch modes:
 - PUNCH IN ONLY** This allows you to automatically punch in only. To stop the recording, press STOP.
 - PUNCH OUT ONLY** This allows you to automatically punch out only. To start recording, press PLAY or PLAY START while holding down REC or OVER DUB.
 - PUNCH IN OUT** Both punch-in and punch-out are executed automatically.
- **IN**
Sets the auto punch in point.
- **OUT**
Sets the auto punch out point.

To start auto punch, press TurnON [F6]. The display returns to the Main Screen and is now in standby mode.

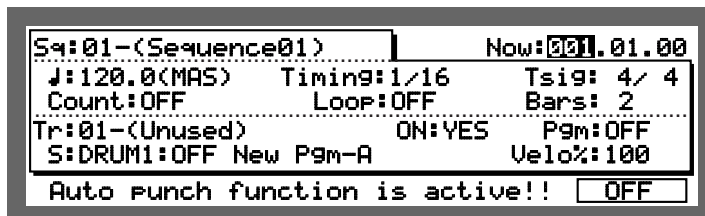

While holding REC or OVERDUB, press PLAY or PLAY START to start recording. Punch in or out will automatically start at the set point and enable you to record your performance.

To cancel auto punch, press OFF [F6] and return to the normal Main Screen.



Chapter 4

Editing Sequences

Overview

There are three ways to edit a sequence. The first is to erase unnecessary note data using the ERASE key. The second is to display and edit each note or event. The third is to specify the bar or note range and edit the data together.

Erasing Data with the ERASE Key

To erase data with the ERASE key, you play back a sequence and erase a random note, or display the note or event and erase them individually.

Erasing a Note in Real Time

It is possible to erase random note data while you are playing back a sequence in Overdub mode.

- ① Select the track with the data you want to erase on the Main Screen.
- ② Either press PLAY or PLAY START while holding OVER DUB or press OVERDUB during playback to switch to Overdub mode.
- ③ Locate the data you want to erase, and while holding ERASE, press the drum pad assigned to the sound.

Besides erasing the drum track, you can erase notes by continuously pressing the note on the MIDI keyboard while holding ERASE.

Using the ERASE Window to Erase Data

When a sequence is not playing, press ERASE to display the ERASE window. You can select and erase specific notes or data sections.

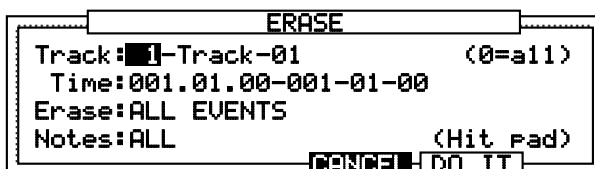

- **Track:**
This specifies the track that you want to erase. If you set this to 0, it will mean that all tracks are selected.
- **Time:**
This sets the range that you want to erase.
- **Erase:**
Select from the following three event types to erase:
 - ALL EVENTS This erases all the events within the range selected in the Time: field. For note events, only the notes set in the Note: field below are erased.

ALL EXCEPT This erases all events except those selected. When ALL EXCEPT is selected, the field on the right enables you to select the event. The events selected here will not be erased. For note events, the notes set in the Note# field below are erased. When notes are selected in the field where events are selected, the Note# field will not appear and all the data except the notes will be erased.

ONLY ERASE This erases only the selected events. When ONLY ERASE is selected, the field on the right enables you to select an event. Only the event selected here will be erased. The Note# field will appear only when NOTES is selected in the event selection field. When NOTES is selected, only the notes set here are erased.

- **Notes#**
This sets the notes that you want to erase.

Note: Depending on whether the track selected in the Track# field is a drum track or MIDI track, the Notes# field display will change as follows:

Drum track



MIDI track

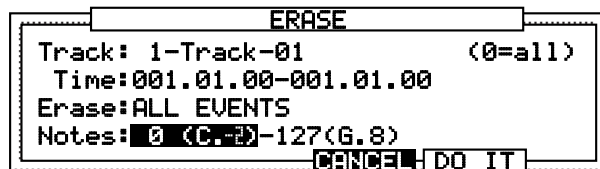

Press DO IT [F5] to erase.

Step Editing

The Step Edit screen allows you to finely edit MIDI data on a track or enter data one at a time from the drum pads or a MIDI keyboard.

Step Editing Screen

From the Main Screen, press STEP [F1] to display the Step Edit screen.

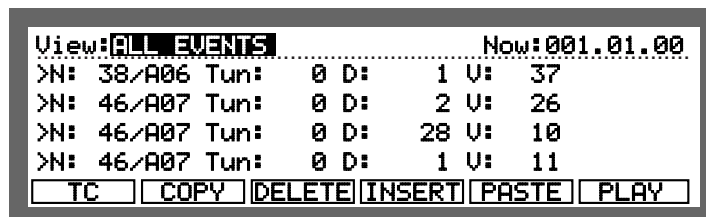

- **View:**

This specifies the type of events:

ALL EVENT	Displays all of the events recorded on a track.
NOTES	Displays only the notes. By selecting NOTES, the note range setting field will also appear. The notes of the range specified here will be displayed.
PITCH BEND	Displays only the pitch bend data.
CTRL#:	Displays only the control change data. By selecting CTRL#, a field to select the control change number will also appear. This field will only display the control change event selected here. When ALL is selected, all of the control change events will be displayed.
PROG CHANGE	Displays only the program change data.
CH PRESSURE	Displays only the channel pressure data.
POLY PRESS	Displays only the poly pressure data.
EXCLUSIVE	Displays only the exclusive data.

Open the Step Edit Options window by selecting a field and pressing OPEN WINDOW.

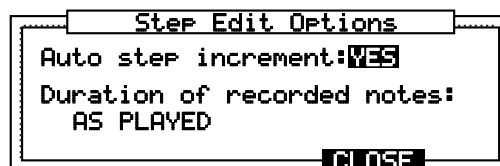

- **Auto step increment:**

After entering data in step input, you can automatically move a sequence according to the value set in the Timing# field on the main screen each time an event is entered from a pad or MIDI keyboard.

Setting this to YES will move the sequence according to the settings in the Timing# field after the drum pad or MIDI keyboard has been released (and the note off has been sent).

- **Duration of recorded notes:**

During step input, this sets the duration of the entered note to either the length of time the key is actually pressed or to a predetermined length.

- AS PLAYED The metronome will play from the moment the drum pad or MIDI keyboard is pressed until it is released.
- TC VALUE: Regardless of the time that the key is actually pressed, the duration will be the value set in the Timing# field. When TC VALUE is selected, the percentage field will also appear. The duration is set against the Timing# field by percentage. For example, if it is set to 50%, the duration is half the amount set in the Timing# field and the result will be a staccato sound.

Timing Correct in “Step Edit”

When the TC [F1] key is pressed, the following window will appear.

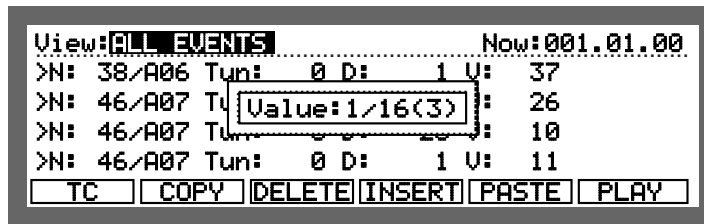

While pressing the key, rotate the DATA wheel to change the value of “Timing Correct”.

For more details, please refer to the “Timing Correct” section.

The Event Display

The note event displayed on the step edit screen will change depending on whether the selected track is a drum track or a MIDI track.

Drum track

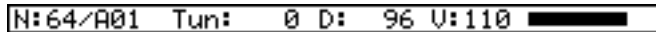

- N#: This is the note number and the Drum Pad number assigned to it.
- Tun#: This field will display the note variation data.
- D#: This is the duration (length of note on).
- V#: This is the velocity (how hard the note is played). The right side will display the velocity value in a bar chart.

MIDI Track

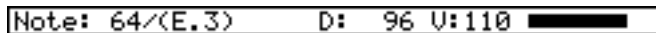

- N#: This displays the note number and note name.
- D#: This is the duration (length of note on).
- V#: This is the velocity (how hard the note is played). The right side will display the velocity value in a bar chart.

Bend



Control Change

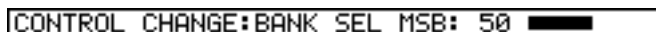

Program Change



Channel Pressure

CH PRESSURE : : 50

Polyphonic Pressure

POLY PRESSURE : 60(C.3) : 50

Exclusive Data

Exclusive:F0 F7

Operating the List Display

When many events are entered at one point and the whole list cannot be displayed, you can scroll through the list with the CURSOR UP or DOWN keys.

Press PLAY [F6] to generate the selected event.

Selecting and Editing Multiple Events

Multiple MIDI events on the display can be selected together by holding SHIFT and selecting the events with the CURSOR UP or DOWN keys. In this case the parameters are displayed as white characters on a blue background.

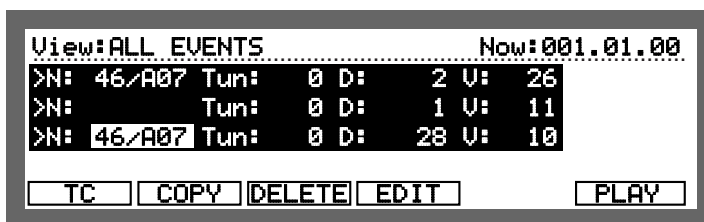

When multiple events are selected, EDIT [F4] appears in place of the function keys INSERT [F4] and PASTE [F5] as shown above.

By pressing EDIT [F4], the Edit Multiple window (corresponding to the field selected with the cursor) will appear.

- ◆ When a note number is selected, all the selected notes are changed to the note number set here. Select the note number with the DATA wheel and press DO IT [F5] to execute.

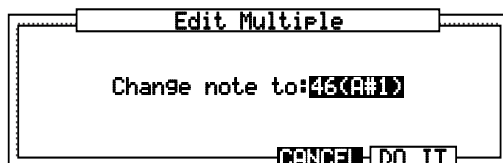

- ◆ When parameters other than note numbers are selected, edit the value of the selected parameter using the window shown below.



- **Edit type:**

Edit the selected parameters according to the following settings.

ADD VALUE	This adds the value set in Value# to the current value.
SUB VALUE	This subtracts the value set in Value# from the current value.
MULT VAL%	This increases or decreases the current value by the percentage set in Value#.
SET TO VAL	This unifies all the parameters to the value set in Value#.

- **Value#:**

This sets the edit method selected in Edit type#.

Copying an Event

To temporarily save the data on the clip board, select an event and execute Copy. To execute Copy, press COPY [F2] after selecting the event.

Deleting an Event

Press DELETE [F3] after selecting the event.

Pasting an Event

To paste data which was copied to the clip board, specify the point where you want to paste it in the Now# field and press PASTE [F5].

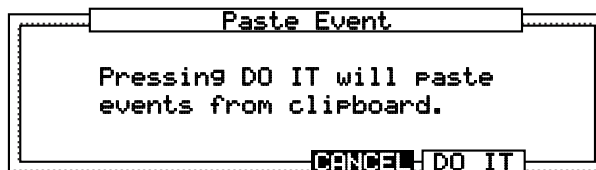

Press DO IT[F5] to execute the paste.

If multiple data with time ranges are saved to the clip board, the following screen will appear when you press PASTE [F5].



Press RPLACE [F4] to erase the data in the specified point and overwrite with the contents of the clip board.

Press MERGE [F5] to merge the data with existing data.

Inserting an Event

To insert an event, specify the point of insertion in the **Now#** field and press **INSERT**[F4].

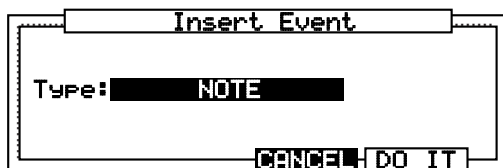

Select the type of event you want to insert from the following:

NOTE, PITCH BEND, CONTROL CHANGE, PROGRAM CHANGE, CH PRESSURE, POLY PRESSURE, EXCLUSIVE and MIXER.

When EXCLUSIVE is selected, a field displaying the byte volume of the exclusive message to be entered appears. Set the volume (byte) of the exclusive message you want to enter.

By pressing **DO IT** [F5], you can return to the step edit screen. Since the event set in the Insert Event window will be inserted, set the parameter with the **CURSOR** keys and **DATA** wheel.

It is also possible to insert a note directly from a drum pad or keyboard. For details, refer to the following "Step Recording."

Step Recording

On the step edit page displayed by pressing **STEP** [F1] on the main screen, it is possible to use the drum pad or a MIDI keyboard to step record.

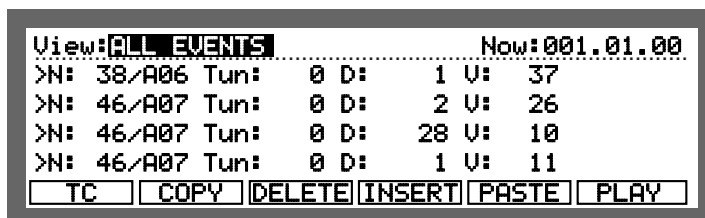

Set the point where you want to enter a note in the **Now#** field and enter the note with a drum pad or MIDI keyboard connected to MIDI IN. In doing so, the velocity (the strength of the note on) or the duration (length of the note) is affected by the entered data.

When **Auto Step Increment#** in the Step Edit Options window (see page 64) is set to YES, during step recording, the **Now#** field points increase by the amount set in the **Timing#** field of the Main Screen each time a note is entered.

The Editing Screen

The editing screen allows you to copy an entire event within a sequence. It is also possible to rearrange the tracks, transpose, or set the preferences of a newly created sequence. To display the editing screen, press **EDIT [F2]** in the main screen.

Event edit

Time and notes are specified here for various types of editing.

Copying an Event

When Copy is selected in the **Edit#** field the following screen is displayed.

Edit# : COPY	From s# : 80 Tr : 1
Time : 001.001.00-001.01.00	To s# : 80 Tr : 1
Notes : ALL	Mode : REPLACE
	Start : 001.01.00
	Copies : 1
EVENTS BARS TrMOVE USER	DO IT

Here you can copy all of the events recorded in a sequence, but it is necessary to set a pad for the drum track and a note range for the MIDI track.

◆ Left Window

- **Time#**:
Set the range of the event you want to copy.
- **Notes#**:
Set the note of the copy source. A pad number will appear if the track is a drum track, and a note range will appear if the track is a MIDI track. You can directly set the copy source from a drum pad or MIDI keyboard.

◆ Right Window

- **From s#/Tr#**:
Select the sequence or track that you want to copy. Here, only the number will appear.
- **To s#/Tr#**:
This selects the sequence or track that you want to copy to. Here, only the number will appear.
- **Mode#**:
This selects whether you will be writing over the existing data (**REPLACE**) or mixing the data (**MERGE**). When **REPLACE** is selected, the event in the copy destination is erased and is replaced with the copy source data. When **MERGE** is selected, the copy destination data and the copy source data is mixed.
- **Start#**:
This specifies the point where you want to start copying. The copy source data will be pasted at the point set here for the number of times set in **Copies#** (below).
- **Copies#**:
This specifies the number of copies. From the point set in **Start#**, the data will be pasted the number of times set here.

To execute the copy, press **DO IT [F6]**.

Editing the Duration of a Note

When DURATION is selected in the Edit: field the following screen is displayed.

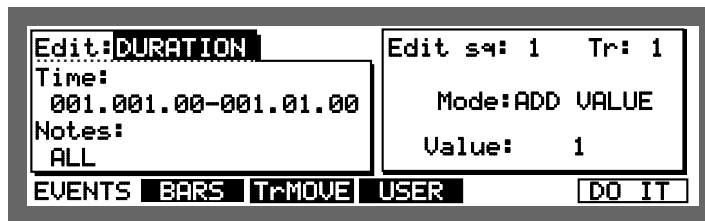

◆ Left Window

- **Time:**
Set the range of the event you want to edit.
- **Notes:**
Set the note you want to edit. A pad number will appear if the track is a drum track, and a note range will appear if the track is a MIDI track. You can directly set the note from a drum pad or MIDI keyboard.

◆ Right Window

- **Edit seq:/Tr:**
To select the sequence and track that you want to edit.
- **Mode:**
Edit the selected parameters according to the following settings.

ADD VALUE	This adds the value set in Value: to the current value.
SUB VALUE	This subtracts the value set in Value: from the current value.
MULT VAL%	This increases or decreases the current value by the percentage set in Value:.
SET TO VAL	This unifies all the parameters to the value set in Value:.

- **Value:**
Set the value to be adjusted here.

Editing the Velocity of a Note

When VELOCITY is selected in the Edit: field the following screen is displayed.

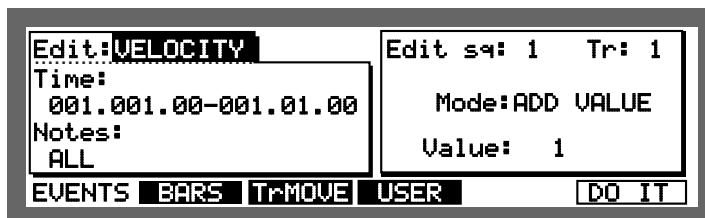

◆ Left Window

- **Time:**
Set the range of the event you want to edit.
- **Notes:**
Set the note you want to edit. A pad number will appear if the track is a drum track, and a note range will appear if the track is a MIDI track. You can directly set the note from a drum pad or MIDI keyboard.

◆ Right Window

- **Edit s#:/Tr#:**
To select the sequence and track that you want to edit.
- **Mode#:**
ADD VALUE
Adds the value selected in the **Value#:** field to the note.
SUB VALUE
Subtracts the value selected in the **Value#:** field from the note.
MULTI VALUE %
Multiplies the velocity (percent) by the value selected in the **Value#:** field.
SET TO VALUE
Sets the note to the velocity selected in the **Value#:** field.
- **Value#:**
Set the value to be adjusted here.

Transposing a Note

When TRANSPOSE is selected in the **Edit#:** field the following screen is displayed.

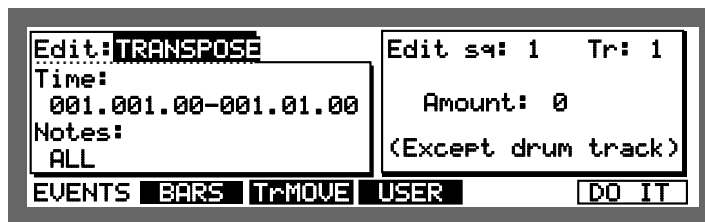

◆ Left Window

- **Time#:**
Set the range of the event you want to edit.
- **Notes#:**
Set the note you want to edit. A pad number will appear if the track is a drum track, and a note range will appear if the track is a MIDI track. You can directly set the note from a drum pad or MIDI keyboard.

◆ Right Window

- **Edit s#:/Tr#:**
To select the sequence and track that you want to edit.
- **Amount#:**
Set the amount to be transposed here (amounts are shown in semi-tone steps).

Note: *Transpose will not function with the drum track.*

Copying by Bar

You can group the data on all of the tracks in a sequence and copy them by bar measures. Press **EDIT** [F2] in the Main Screen to display the event copy screen and press **BARS** [F2].

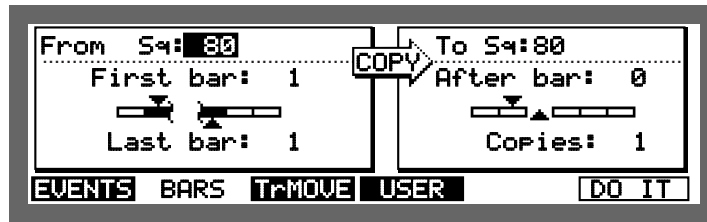

Set the range of bars to be copied in the left window and set the destination you want them copied to in the right window.

All of the tracks in the sequence will be copied and inserted at the point set in the right window.

◆ Left window

- **S4:**
This selects the sequence that you want to copy. Only the sequence number is displayed.
- **First bar:**
This specifies the first bar of the sequence to be copied.
- **Last bar:**
This specifies the last bar of the sequence to be copied.

◆ Right Window

- **S4:**
This selects the sequence that the copy will be inserted into. Only the sequence number is displayed.
- **After bar:**
The copy is pasted after the bar set here. The original data will not be overwritten, the new data will push back the initial data.
- **Copies:**
This specifies the number of times that the copy is inserted into the sequence.

CAUTION: *When you copy by bar, the data among corresponding tracks will be copied. For example, the data on track 1 will be copied to track 1 and track 2 to track 2 and so on.*

Rearranging the tracks

This allows you to rearrange/move tracks within a sequence.

From the the Main Screen, press EDIT [F2] to display the Event Copy screen and press TrMOVE [F3].

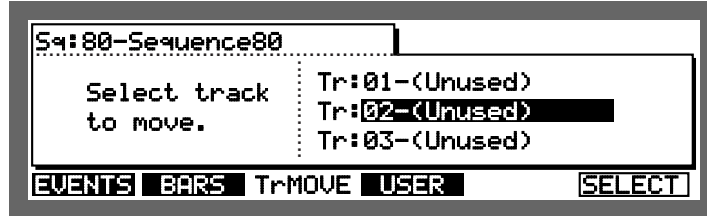

Select the sequence in the S#: field and then move the cursor to the field where the track is displayed using the CURSOR DOWN key. Select the track that you want to move with the DATA wheel and press SELECT [F6].

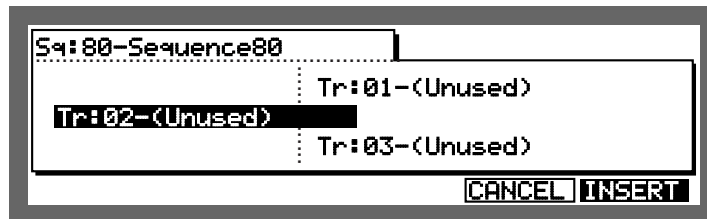

The selected track moves to the left. If you rotate the DATA wheel again, the list on the right will scroll.

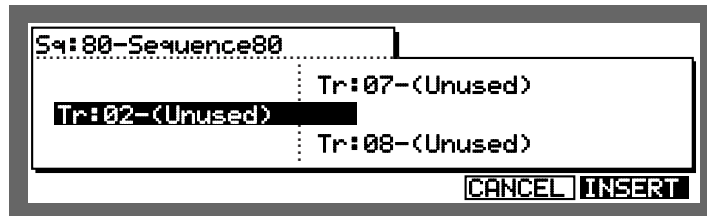

When you reach the place that you want to insert the track, press INSERT [F6].

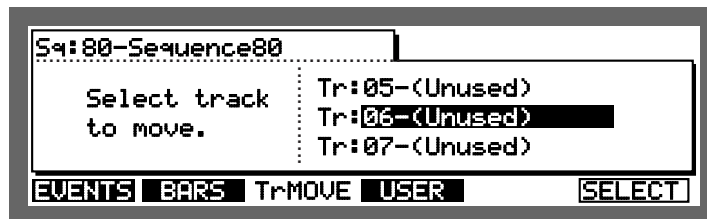

The track name remains the same as the original and the new track numbers are set in order.

Sequence Preferences

This sets the preferences of the main screen for when you create new sequences. From the main screen, press **EDIT** [F2] to display the Event Copy screen, then press **USER** [F5].

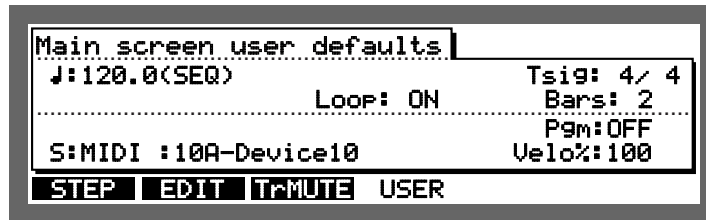

Select the field with the CURSOR keys and set the parameter with the DATA wheel. Only the fields shown here can be set as preferences.

For details regarding parameters, refer to the “Main Screen” section.

Transposing a Track

Here you can transpose the pitch of a track.

Hold down **SHIFT** and press **MISC.** (numeric key 2), then press **TRANS** [F2].

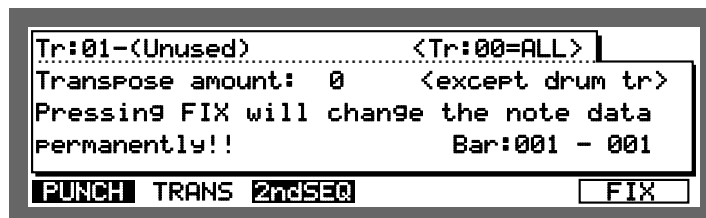

- **Tr:**
This selects the track that you want to transpose. When this is set to 00, all the tracks will be transposed. However, drum tracks will not be affected by the transposition.
- **Transpose amount:**
This sets the amount of transposition. You can set up to plus/minus twelve for each half tone. Plus twelve is one octave up and minus twelve is one octave down. The settings here do not directly change the data but only transpose the data when they are played back.
- **Bar:**
Set the range of bars that are to be transposed here (left hand figures = from bar / right hand figures = to bar).

Press **MAIN SCREEN** to return to the Main Screen.

#b will be displayed to the left of the **Now:** field when a track has been transposed.

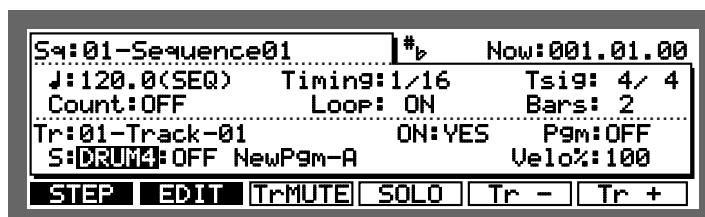

Note: **#b** will not be displayed when data is transposed with the **FIX** [F6] key.

To transpose and change the data, press FIX [F6].

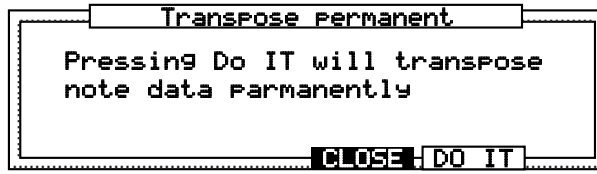

Press DO IT [F5], the data is transposed to the settings in Transpose amount:.



Chapter 5

Song Mode

Overview

There are two main ways to create music data on the MPC2000XL. One way is to create a long sequence as a whole piece, the other way is to create short sequences and play them sequentially as a Song.

The Song Mode sequentially plays the data of selected sequences. You can set the order or number of times to play each sequence. This is used to play multiple pieces consecutively, or to complete a song by arranging the sequences for each part. The advantages of using the Song Mode are as follows:

- The song can be created quickly.
- The contents of each section of the song can be changed quickly.

A song can consist of up to 250 steps, each of which contains the number of the sequence that will play at that step and the number of times the step will repeat before going on to the next step in the song.

Up to 20 songs can be stored in memory at one time. Recording can not be carried out in Song Mode, the individual sequences must be recorded or edited from the Main Screen.

Song Mode

Hold down SHIFT and press SONG (1 on the numeric keypad). The Song Mode screen will appear:

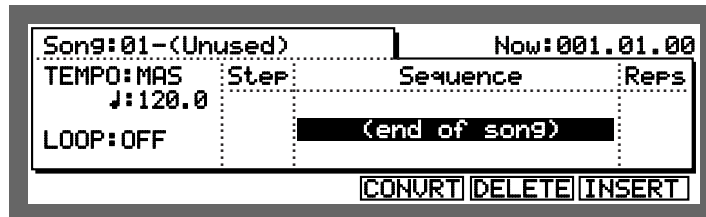

While this screen is displayed the Song Mode is active, this means that if playback is started, the active song will play instead of the active sequence.

All of the Play/Record keys (except RECORD and OVERDUB) operate the active song. PLAY START plays the song from the start; PLAY plays the song from the current location in the Now# field; the REWIND, FAST FORWARD, and LOCATE keys change the position within the song.

Creating a Song

To newly create a song, select an (Unused) song in the Song# field. Select (end of song) in the Sequence field with the CURSOR keys.

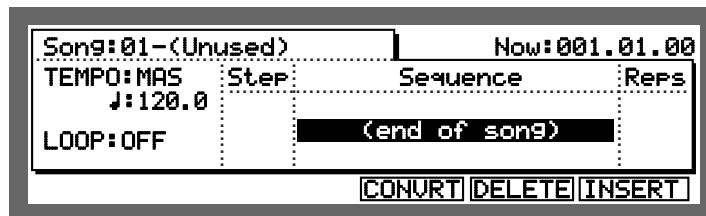

Select the sequence by rotating the DATA wheel. The sequence will be assigned to the first step of the song.

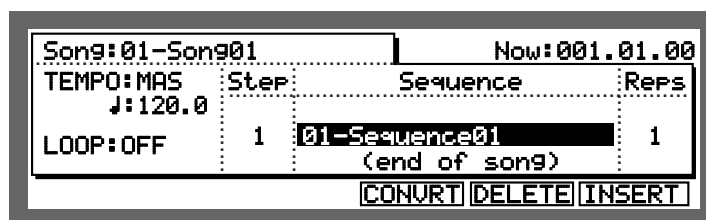

Select (end of song), with the CURSOR DOWN key.

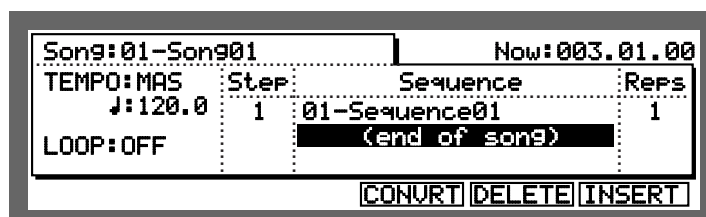

Select the next sequence (assigned to Step 2), with the DATA wheel.

Song:01-Song01		Now:003.01.00	
TEMPO:MAS ↓:120.0	Step	Sequence	Reps
	1	01-Sequence01	1
LOOP:OFF	2	02-Sequence02	1
		(end of song)	
CONVRT DELETE INSERT			

In the same way as above, assign sequences and increase the number of steps.

Renaming a Song

To open the Song window, select the Song# field and press OPEN WINDOW.

SONG	
Song name: Song01	
Default name : song	
DELETE	CLOSE COPY

- **Song name:**
Changes the name of the song.
Tap a drum pad or rotate the DATA wheel to display the name window.

Press ENTER after you have entered the name.

Note: If you do not press the ENTER key and move the Default Name: field or other pages with the CURSOR DOWN key, the entered name will be ignored and the name will not change.

- **Default name:**
This sets the name that will automatically be used when data is entered into a new song (titled "Unused"). Enter the name in the same way as for the Song name.

Selecting a Song

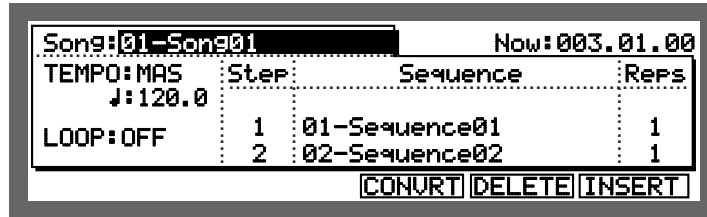

Song: 01-Song01		Now: 003.01.00	
TEMPO: MAS	Step	Sequence	Reps
♩: 120.0			
LOOP: OFF	1	01-Sequence01	1
	2	02-Sequence02	1
CONVRT DELETE INSERT			

Move the cursor to the **Song#** field and select a song by rotating the DATA wheel. The song number and song name will appear. If there is no data in the song, **(Unused)** will appear.

Deleting a Song

From the song screen, select the **Song#** field and press OPEN WINDOW. To open the Delete Song window, press **DELETE** [F2].



The currently selected song is erased when **DO IT** [F5] is pressed and the song name will change to **(Unused)**.

If you press **ALL SG** [F3] the following warning will appear and all the songs will be erased if you press **DO IT** [F5].

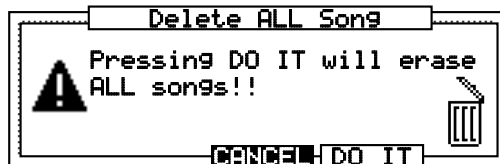

Copying a Song

From the song screen, select the **Song#:** field and press the OPEN WINDOW key. To open the Copy Song window, press **COPY**[F5].

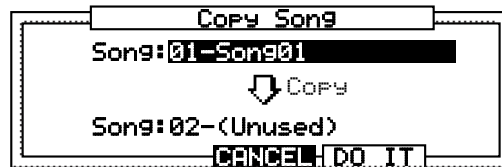

Select the song that you want to copy (top level) with the DATA wheel. Select the copy destination (bottom level) by pressing the CURSOR DOWN key and select the song that you want to copy the data to with the DATA wheel.

To copy the song data, press **DO IT** [F5].

CAUTION: *If there is data in the song you have selected as the destination, the data will be erased if you press F5. Be careful when you are copying to a song with a name other than "Unused."*

Setting the Tempo

This sets the tempo of the song.

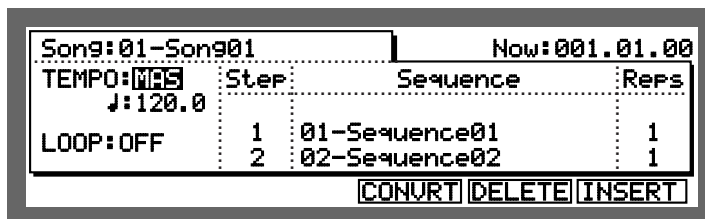

- TEMPO:**

This sets the sequence to either be played in the tempo it was recorded in or the Master tempo. Move the cursor to the TEMPO: field and set the tempo source by rotating the DATA wheel.

 - SEQ** The song will be played at the tempo specified in the sequence. In this case it is not necessary to change the tempo in the ♩: field.
 - MAS** All the sequences in the song will be played at the Master tempo specified in the ♩: field.
- ♩:**

Set the tempo of the song, if MAS is selected in the TEMPO: field. Move the cursor to the ♩: field and set the tempo by rotating the DATA wheel. Enter 4 digits if you are using the numeric pad to enter. For example, to set the value to 120.5, enter "1205" and press ENTER. To set the value to 88.5, enter "885" and press ENTER. When SEQ is selected in the TEMPO: field, you can not change the tempo. The current tempo of the sequence is displayed in this field.

To open the Tempo Change window, select the TEMPO: or ♩: field and press the OPEN WINDOW key.

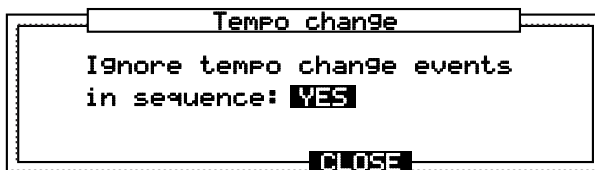

Specify whether the tempo change recorded within the sequence should be ignored. If YES is selected, the tempo change in the sequence will be ignored. If NO is selected, the tempo change in the sequence becomes valid and the tempo of the song will change according to the data.

Setting the Loop

This allows you to repeatedly play a loop of a specified number of steps of the song until STOP is pressed.

Song: 01-Song01		Now: 001.01.00	
TEMPO: MAS	Step	Sequence	Reps
J: 120.0			
LOOP: OFF	1	01-Sequence01	1
	2	02-Sequence02	1
CONVRT DELETE INSERT			

Select the LOOP: field with the CURSOR keys and rotate the DATA wheel to select ON (set to OFF to cancel the loop mode).

To set the range of the loop, press OPEN WINDOW.

LOOP	
First step:	1
Last step:	1
Number of steps:	2
CLOSE	

- **First step:**
Specifies the first step of the loop.
- **Last step:**
Specifies the last step of the loop.
- **Number of steps:**
This sets the range of the loop by the number of steps. The song will loop from **First step:** for the number of bars set here.

CAUTION: *The **First step:** and the **Number of steps:** as well as the **Last step:** and the **Number of steps:** affect each other. If you change the **First step:** or **Last step:**, the value of **Number of steps:** will change accordingly.*

Selecting a Step and Changing the Sequence

Select the step number in the **Step** field with the CURSOR keys. If there are a lot of steps, press the CURSOR UP or DOWN key to scroll up and down the screen. You can also use the DATA wheel to select the step.

Song:01-Song01		Now:003.01.00	
TEMPO:MAS	Step	Sequence	Reps
J:120.0	1	01-Sequence01	1
LOOP:OFF	2	02-Sequence02 (end of song)	1
CONVRT DELETE INSERT			

To change the sequence assigned to that step, move the cursor to the **Sequence** section with the CURSOR RIGHT key.

Song:01-Song01		Now:003.01.00	
TEMPO:MAS	Step	Sequence	Reps
J:120.0	1	01-Sequence01	1
LOOP:OFF	2	03-Sequence03 (end of song)	1
CONVRT DELETE INSERT			

Change the sequence with the DATA wheel.

Repeating a Sequence

The sequence assigned to the step can be repeated a number of times. Select the **Reps** field of the sequence you want to repeat with the CURSOR keys.

Song:01-Song01		Now:003.01.00	
TEMPO:MAS	Step	Sequence	Reps
J:120.0	1	01-Sequence01	3
LOOP:OFF	2	02-Sequence02	1
CONVRT DELETE INSERT			

Set the number of times the sequence is to be repeated with the DATA wheel.

CAUTION: If this is set to 0, the sequences after that step will not be played.

Deleting a Step

Select the step number or sequence that you want to delete with the CURSOR keys and press DELETE[F5].

When the step is deleted, the following steps will all be moved up.

Song:01-Song01		Now:007.01.00	
TEMPO:SEQ	Step	Sequence	Reps
♩:120.0	1	01-Sequence01	3
LOOP:OFF	2	03-Sequence03 (end of song)	1
CONVRT DELETE INSERT			

Song:01-Song01		Now:007.01.00	
TEMPO:MAS	Step	Sequence	Reps
♩:120.0	1	01-Sequence01	3
LOOP:OFF	2	03-Sequence03 (end of song)	1
CONVRT DELETE INSERT			

Inserting a Step

Select the step number or sequence where you want to insert the new step with the CURSOR keys and press INSERT[F6]. The new step is inserted after the selected step.

The steps after the selected one will move one step back and sequence 01 will be inserted.

Move the cursor to the Sequence field of the new step and select a new sequence by rotating the DATA wheel.

Moving to a Specific Point in the Song

Select the **Now#** field with the CURSOR keys and set the point in the song that you want to go to with the CURSOR keys and DATA wheel.

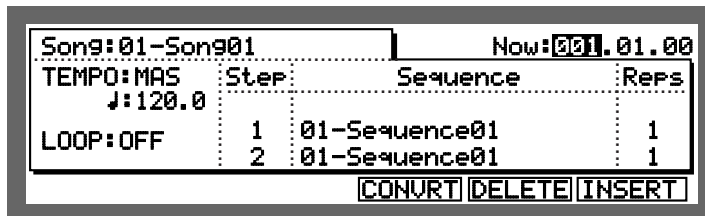

You can set the **Now#** field to display either bar/beat/clock or hours/minutes/seconds. While still on the **Now#** field, press OPEN WINDOW.

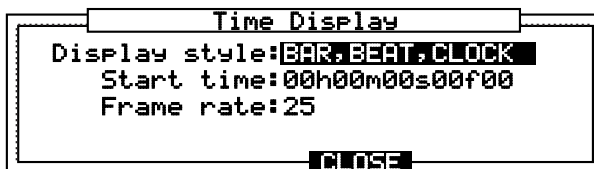

- **Display style:**
Select either BAR, BEAT, CLOCK or HOUR, MINUTE, SEC.
- **Start time:**
Select HOUR, MINUTE, SEC in Display style: to start the time display on the main screen from the time set in this field. This is also the start time when synchronizing to MTC or SMPTE time code.
- **Frame rate:**
This sets the frame rate of the time code used when synchronizing to MTC or SMPTE time code. Synchronization is described in the "MIDI/SYNC Mode" section.

Converting a Song to a Sequence

The song mode function is convenient when assembling a song. When editing detailed data within a song that has a complicated structure, it's easier to assemble the song as 1 sequence and then edit that sequence. In this type of case, it is a good idea to create the basic structure of the song using the song mode and then convert that to one sequence. By doing that you can then use the sequence's edit function to further edit the song. When converted, the song's complete sequence will be converted to a newly created sequence.

Note: Sequence settings set in step 1 of the song will be applied as the settings of the new sequence such as track name, track type (Drum or MIDI), MIDI OUT channel assign, MIDI Program Change Assign, mixer, tuning, tempo etc.. Also, song loop settings will be made effective by the converted sequence.

To convert the song, press **CONVRT** [F4].

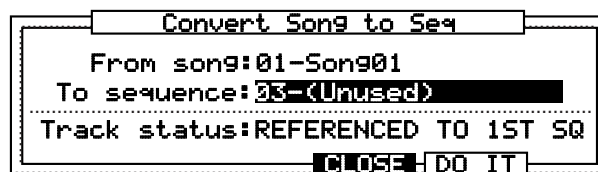

- **From song:**
This selects the song that you want to convert.
- **To sequence:**
This selects the sequence where the song will be converted to.
- **Track status:**
Here you can select what the track status will be after conversion to a sequence.

REFERENCED TO 1ST SQ

The settings (MIDI output, stereo mixer settings, tempo settings, etc.) in each track of the first sequence will be assigned to all of the following sequences.

OFF TRACKS IGNORED

Tracks that have been turned off (track "ON:" is set to "NO" on the Main Screen) will not be converted. All tracks will be turned on after conversion, but the data in tracks that have been turned off will be blank.

All the parameter settings of the first sequence will be used for the new sequence.

MERGED ON MIDI CH

Each sequence will be merged according to their MIDI output channels to the corresponding tracks.

For example:

All track data of MIDI channels 1A-16A will be merged to tracks 1-16

All track data of MIDI channels 1B-16B will be merged to track 17-32

Drum tracks 1 - 4 will be merged to tracks 33 - 36 consecutively.

The Exclusive data will be merged to tracks 1-32 according to the MIDI channel assigned on each track.

To convert, press **DO IT** [F5].

CAUTION: If there is data in the sequence you have selected as the destination, the data will be erased. Be careful when you are converting to a sequence with a name other than "Unused".
If the size of the sequence will exceed 50,000 notes after conversion, it will not be converted.



Chapter 6

Creating and Editing Sounds

Sampling a New Sound

Sampling is done in 16-bit linear format with the same 44.1kHz sampling rate as used with compact discs.

CAUTION: *All sounds are lost when the power is turned off. This means that you must load in sounds from a disk every time the MPC2000XL is turned on, and you must save any edited or newly sampled sounds to disk, or the changes will be lost!*

To sample a sound, hold down SHIFT and press SAMPLE (or 4 on the numeric pad) to display the sampling screen.

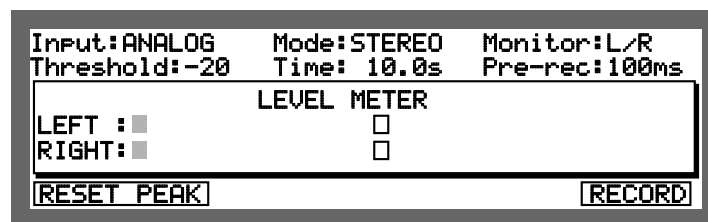

- **Input:**

You can choose from the following two sound sources.

- ANALOG** The recording source is connected to the rear panel analog RECORD IN jacks.
- DIGITAL** The recording source is connected to the DIGITAL input on the rear panel. This input can be connected to any 44.1kHz digital SP/DIF source such as a CD or DAT tape recorded at 44.1kHz, but 48 kHz sources are not supported.

CAUTION: *You can only choose DIGITAL when the optional IB-M208P board is installed.*

- **Mode:**

Set the mode to STEREO or MONO input.

- MONO L** Sampling is done in mono, using only the left RECORD IN (or the LEFT signal of DIGITAL IN). The mono signal is monitored at both the left and right sides of the stereo outputs, but the level meter will only show LEFT.
- MONO R** Sampling is done in mono, using only the right RECORD IN (or the RIGHT signal of DIGITAL IN). The mono signal is monitored at both the left and right sides of the stereo outputs, but the level meter will only show RIGHT.
- STEREO** Sampling is done in stereo, using both the LEFT and RIGHT RECORD IN (or the LEFT and RIGHT signals of DIGITAL IN).

- Monitor:**
 When L/R is selected, the sound from the input is sent to the stereo mix outputs. When OFF is selected, it is not sent. If you are sampling with a microphone in the same room as the speakers, select OFF to avoid audio feedback. Otherwise, select L/R to hear the sound in the stereo mix.
 If the optional IB-M208P is installed, you can select outputs 1/2, 3/4, 5/6 or 7/8 to monitor the sounds from the Assignable Mix Out jacks.
- Threshold:**
 This sets the threshold value at which auto sampling starts. Once RECORD [F6] is pressed, sampling starts when the signal exceeds the value set here. The threshold value is displayed on the meter with a □.
 If the value set here is too high, sampling will not start even if you enter a sound. If it is too low, a small noise may cause the sampling to start. If this is set , sampling will start the moment RECORD [F6] is pressed regardless of the input level.
- Time:**
 This is used to specify the sample time to be allocated to the sample, in seconds (in 0.1 second steps). Any number can be entered here up to the maximum available sampling time. In a non-expanded MPC2000XL, the maximum sampling time is 21.9 seconds mono or 10.9 seconds stereo. In a fully expanded MPC2000XL (total 32 megabytes) the maximum sampling time is 378.6 seconds mono or 189.2 seconds stereo.

CAUTION: *Although the maximum sampling time is limited only by memory capacity, the maximum sound file size that can be saved on a floppy disk is 16.4 seconds mono or 8.2 seconds stereo. If a sound is larger than this, it won't fit on a single floppy and the MPC2000XL cannot split single sound files over two or more floppies. If you need to create longer sounds and save them to disk, it is necessary to use an external hard disk connected to the SCSI port.*

- Pre-rec:**
 When sampling, it is possible to record sounds before the level threshold is exceeded. In this field, set that prerecord time, in milliseconds. For example, to record 10 milliseconds before the threshold is exceeded, enter 10 here. The default value here is the maximum 100 milliseconds.

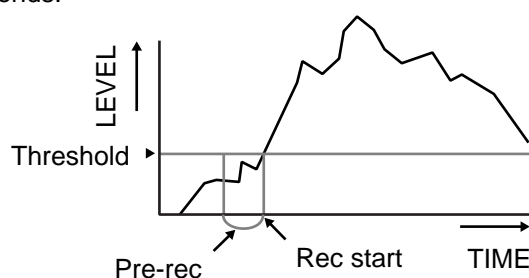

CAUTION: *In playback, the sound starts playing from the point at which the threshold was exceeded because the Start Point parameter (in the Edit a Sound screen) is automatically set to the first sample which exceeded the threshold. To hear the prerecord portion of the sound, you must set the Start Point field to an earlier position within the sound.*

- LEVEL METER

While this screen is displayed, the meter will constantly display the level of the signal input. The threshold setting is graphically represented by a □ within the meter's range. In addition, a ✖ shows the highest peak level received since the last time the RESET PEAK[F1] was pressed.

If the recorded level is too high, the sampled sound will be distorted. On the other hand if it is too low, white noise will be noticeable. When you are recording set the level to the maximum within the range where the meter does not entirely hit the limit. Set the level using the REC GAIN knob. It is not possible to change the level with the REC GAIN knob if you are recording digital input and DIGITAL is selected in the Input# field.



By pressing RESET PEAK [F1], the peak displayed on the LEVEL METER will be reset.

By pressing RECORD [F6], the MPC2000XL will go to the recording standby mode and the following will be displayed.

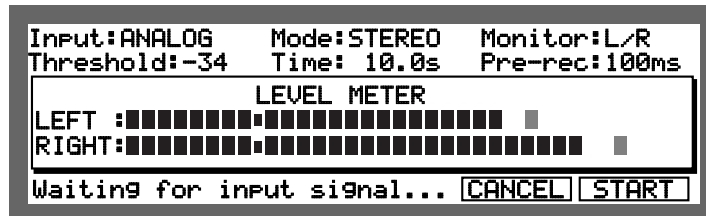

When a signal exceeding the threshold value is received, sampling will start.

To cancel sampling during the recording standby or recording modes, press CANCEL [F5].

To manually start sampling, before the value exceeds the threshold, press START [F6].

During recording, the following display will appear.

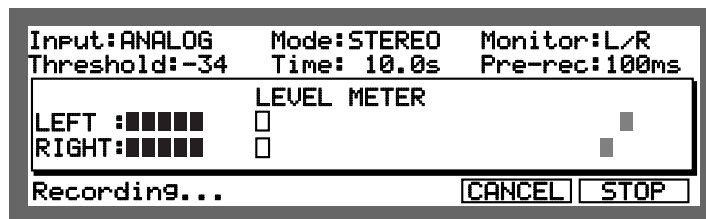

Sampling will end when the time set in Time# field is reached. The sampling will also end when STOP [F6] is pressed during sampling. Sampling will be interrupted when CANCEL [F5] is pressed and will return to the original display.

The following window will be displayed when sampling is finished.

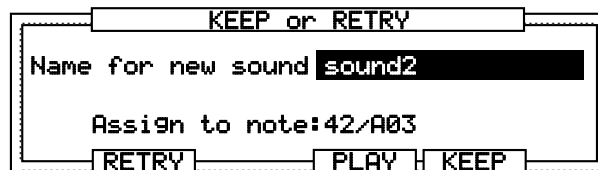

To listen to the sampled sound, press PLAY [F4].

When RETRY [F2] is pressed, the sampled sound will be discarded and the display will return to the original display.

Before saving a sampled sound, first set the following fields:

- **Name for new sound:**
Enter a name for the sampled sound here.
Tap a drum pad or rotate the DATA wheel to display the Name window.

Enter a name and press ENTER [F5] to confirm.

Note: If you do not press ENTER and move to another page, the name and the sound will not be saved.

- **Assign to note:**
This assigns a sampled sound to a drum pad. When sampling is complete, it is possible to play the sound which has just been recorded with the selected pad. Select this field with the CURSOR DOWN key and select the note number of the drum pad with the DATA wheel or by hitting one of the drum pads. The note number of the pad will appear. When you do not want to assign a sound to a pad, select ---/OFF with the DATA wheel.

When KEEP [F5] is pressed, the sample will be stored into the memory and the display will return to the original display.

To listen to the sample, press MAIN SCREEN to return to the main screen and press the drum pad that you assigned the sample to.

By pressing OPEN WINDOW while the sample mode screen is displayed, the Sound memory window will appear regardless of the cursor position.



The available sampling time and the total memory capacity are displayed.

Note: The RECORD IN jacks on the rear panel are balanced inputs having a hot, cold and ground connection using a standard stereo phone jack:

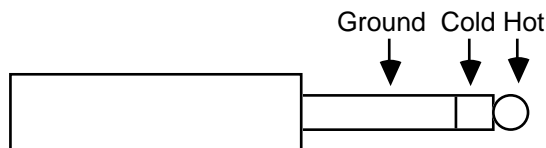

Standard mono phone plugs can also be used for sampling. The cold connection will simply connect to ground.

Editing a Sound

This allows you to edit a sound loaded from a disk or sampled into the memory.

Hold down SHIFT and press TRIM (or 5 on the numeric pad), the TRIM mode screen appears.

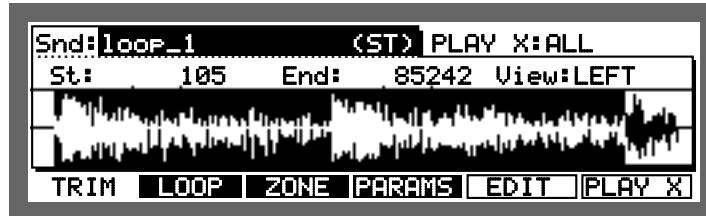

Sound display and order can be changed while in the TRIM, LOOP or ZONE screens, by pressing the TRIM, LOOP or ZONE key again (example: F2 in the LOOP page) The display can be toggled between Memory (order recorded in memory), Size (order of file size), Name (alphabetical order).

Selecting a Sound

Move the cursor to the Snd#: field and select the sound by rotating the DATA wheel. With stereo samples, (ST) will appear after the sample name.

Renaming or Displaying the Specification of the Sound

To open the Sound window, select the Snd#: field and press OPEN WINDOW.

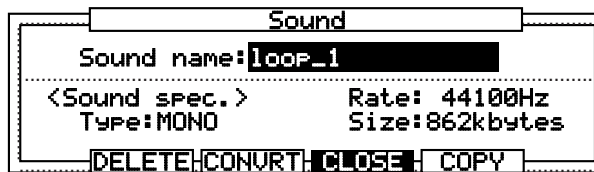

- **Sound name:**
This changes the name of the sound.
Tap a drum pad or rotate the DATA wheel to display the name window.

Enter a name and press the ENTER key to confirm.

Note: If you do not press ENTER and move to another page, the name will not be saved.

- <Sound spec.>

This displays the specifications of the currently selected sound. You cannot change the value here.

- Type#: Displays stereo or monaural mode.
- Rate#: Displays the frequency of the sample.
- Size#: Displays the data size of the sound.

Deleting a Sound

To open the Sound window, select the Snd#: field and press OPEN WINDOW.

Press DELETE [F2] to open the Delete Sound window.

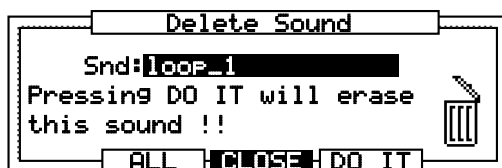

Select the sound you want to delete in the Snd#: field and press DO IT [F5].

If you press ALL [F3], the following warning will appear. All the sounds can be erased when DO IT [F5] is pressed.

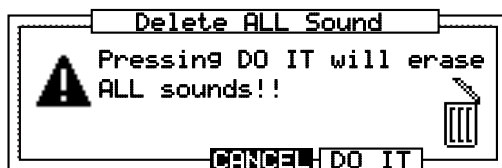

Copying a Sound

To open the Sound window, select the Snd#: field and press OPEN WINDOW.

Press COPY [F5] to open the Copy Sound window.

Select the sound to be copied with the DATA wheel.

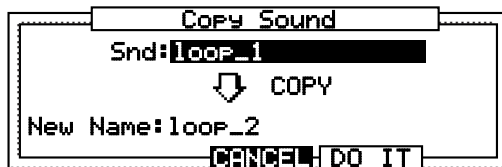

Move to the New name#: field with the CURSOR DOWN key and enter a name for the copy. Tap a drum pad or rotate the DATA wheel to display the name window.

Press ENTER [F5] to save the new name.

Press DO IT [F5] to copy the sound.

Converting a Sound

You can convert a stereo sound into 2 mono sounds, as well as converting 2 mono sounds into one stereo sound.

Note: Since the sound conversion is to create a new sound file, please check that there is sufficient memory available before the conversion.

Selecting Sound

While the cursor is on the `Snd#` field in the TRIM mode, press OPEN WINDOW.

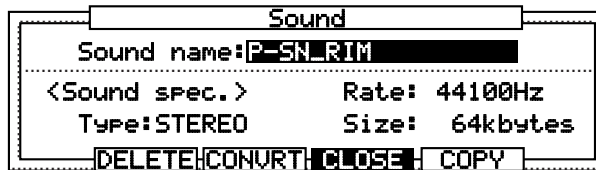

Sound name:

You can choose a new name for the sound here (if you do not want to change the name, press CONVRT [F3]). Tap a drum pad or rotate the DATA wheel to display the name window.

Press ENTER [F5] to save the new name, then press CONVRT [F3].

Converting Stereo to Mono

When a stereo file is selected, the following window will appear.

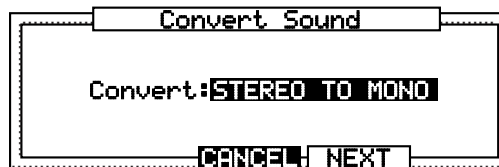

Press NEXT [F5].

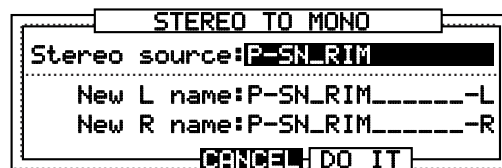

Give the new mono sounds names at `New L name:` and `New R name:` fields. The default names will be the original name with L and R suffixes added.

Commence the conversion by pressing DO IT [F5].

Converting Mono to Stereo

When a mono sound is selected, the following window will be displayed.

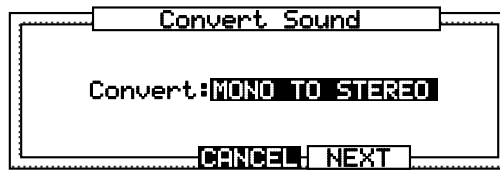

Press NEXT [F5].

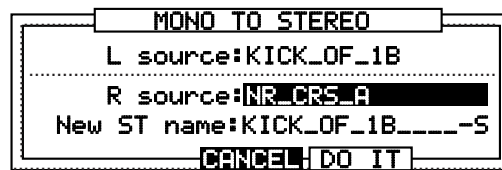

L source= field is the name of sound selected. This source will be the left channel of a stereo sound to be created.

Select the sound for the right channel at R source= field. If the stereo sound is selected here, only the left channel data of that sound will be used.

Enter the sound name for the stereo converted sound in the New St name= field. The default sound name will be the L source sound name with suffix S added.

Press DO IT [F5] to execute.

Note: If the length of the L and R sources are different, the R source will automatically be adjusted to the same length as that of the L source. That is, if the R source is longer than the L source, the excess part of the R source sound will be cut off. If the R source sound is shorter, silence will be added to fill in.

Re-sampling

Re-sampling allows you to change the sampling frequency of the sample. This is useful for conserving memory or it can be used to 'creatively' change the quality of the sound (to 'dirty it up' a little).

From the TRIM, LOOP or ZONE screen, select the Snd#: field and press OPEN WINDOW.

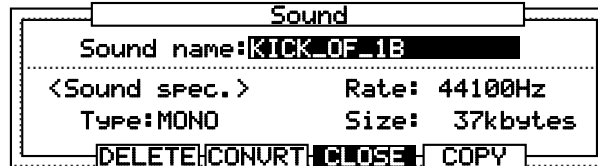

Press CONVRT [F3] and select RE-SAMPLE with the DATA wheel.

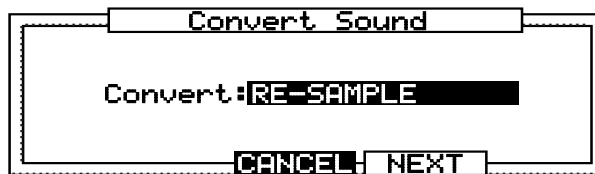

Press NEXT [F5].



New Fs:

This sets the new frequency of the sample.

Quality:

This sets the quality of the sample.

LOW: Least quality but fastest processing.

MED: Moderate quality and relatively fast processing.

HIGH: Best quality but slow processing.

New bit:

You can change the 'bit' resolution here, generally this is best left at 16, but you can experiment with lower settings to get a less clean sound.

New name:

Enter a new name for the sample here with the DATA wheel or drum pads.

Press ENTER [F5] when you have finished.

Press DO IT [F5] to convert the sample.

Note: As re-sampling uses program memory, there must be more than 4 programs empty of data before re-sampling can be carried out.

TRIM Mode

This allows you to trim a sound by selecting new start and end points. The wave pattern of the entire sound is displayed and the area between the start and end points will be displayed in white on a blue background.

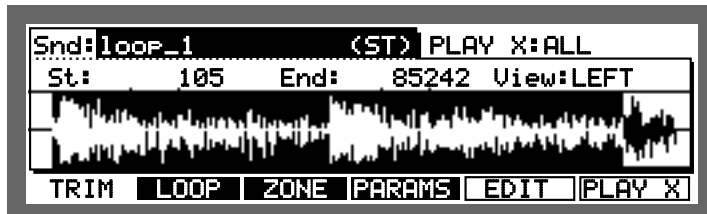

- **St:**
Set the start point where you want the sound to start from when played back by selecting the **St:** field with the cursor and changing the value with the DATA wheel. You can enter large numbers by entering a number with the numeric pad and then pressing ENTER. You can also use the NOTE VARIATION slider while holding the SHIFT key.
- **End:**
Set the end point where you want the sound to end when played back by selecting the **End:** field with the cursor and changing the value with the DATA wheel. You can enter large numbers by entering a number with the numeric pad and then pressing ENTER. You can also use the NOTE VARIATION slider while holding the SHIFT key.
- **View:**
If the sound is in stereo, select whether to display on LEFT or RIGHT channel.

To play back the currently selected sound at full velocity according to the **PLAY X:** field on the top right of the screen, press **PLAY X** [F6].

ALL	This plays back the entire sound regardless of the start or end point settings.
ZONE	This plays back the range between the start and end point that has been set in the ZONE screen.
BEFOR ST	This plays back the sound before the start point that has been set in the TRIM screen.
BEFORE TO	This plays back the sound before the TO (Loop to) point that has been set in the LOOP screen.
AFTR END	This plays back the sound after the end point, that has been set in the TRIM screen.

Fine Adjustment of the Start Point

Select the **St#** field and press OPEN WINDOW to open the Start fine window.



- **Start#**
Set the start point. Change the value with the DATA wheel or enter a number with the numeric pad and press ENTER.
- **Ln9th=**
The length of the sample (from the start point to the end point) is displayed. You cannot change the value of this field.
- **Smp1 Ln9th#**
This sets a fixed point of either the end point or the length of the sample.
 - VARI** When the start point is changed, the end point remains fixed and the length of the sample changes.
 - FIX** When the start point is changed, the length of the sample remains fixed and the end point moves.

You can enlarge or reduce the sample wave display by pressing **ZOOM+** [F3] or **ZOOM-** [F2]. Press **ZOOM-** [F2] to display the entire wave and set a rough start point then press **ZOOM+**[F3] several times to make fine adjustments.

When **PLAY X** [F6] is pressed, you can play back the currently selected sound at full velocity according to the settings in the **PLAY X#** field. For details refer to "TRIM Mode" on the previous page.

Fine Adjustment of the End Point

Select the **End#** field and press OPEN WINDOW to open the End fine window.



- **End#**
Set the end point. Change the value with the DATA wheel or enter a number with the numeric pad and press ENTER.
- **Ln9th=**
The length of the sample (from the start point to the end point) is displayed. You cannot change the value of this field.
- **Smp1 Ln9th:**
This sets a fixed point of either the end point or the length of the sample.
 - VARI** When the end point is changed, the start point remains fixed and the length of the sample changes.
 - FIX** When the end point is changed, the length of the sample remains fixed and the start point moves.

You can enlarge or reduce the sample wave display by pressing **ZOOM+** [F3] or **ZOOM-** [F2]. Press **ZOOM-** [F2] to display the entire wave and set a rough end point then press **ZOOM+** [F3] several times to make fine adjustments.

When **PLAY X** [F6] is pressed, you can play back the currently selected sound at full velocity according to the settings in the **PLAY X#** field. For details refer to the "TRIM Mode" section.

LOOP Mode

Set the loop of the sound. Set to play loops, such as a phrase sample, in this mode.

Hold SHIFT and press TRIM (or 5 on the numeric pad), then press LOOP [F2].

- **To:**
This sets the turn of the loop. Select the **To:** field with the cursor and change the value with the DATA wheel. You can enter large numbers by entering a number with the numeric pad and then pressing ENTER.
You can also use the NOTE VARIATION slider while holding the SHIFT key.

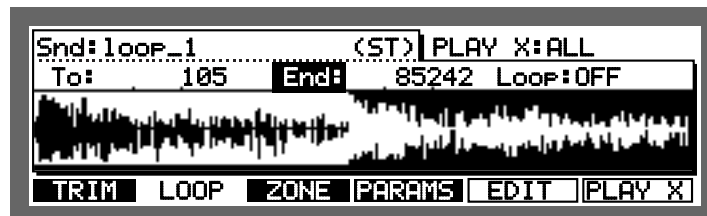
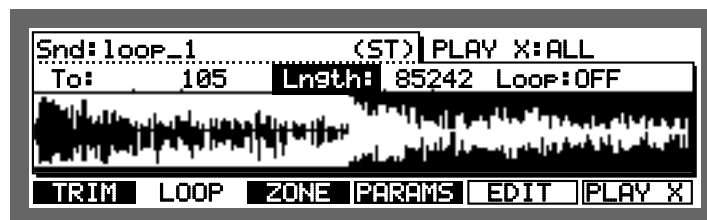

- **Lngth:/End:**
This sets the length of the loop.
You can select either **Lngth:** or **End:** by placing the cursor here and turning the DATA wheel.
Select the field to the right of **Lngth:/End:** with the cursor and change the value with the DATA wheel. You can enter large numbers by entering a number with the numeric pad and then pressing ENTER.
You can also use the NOTE VARIATION slider while holding the SHIFT key

Lngth: this indicates the length of the loop between the **To:** and **End:** points.
End: this indicates the **End:** point.

- **Loop:**
This turns the loop ON or OFF.

Press FIT [F5] to display the Fit to length window.

This function enables you to set the loop length to the same as that set in the TRIM mode. Press DO IT [F5] in the Fit to length window to execute this function.

By pressing PLAY X [F6], the currently selected sound will play back at full velocity according to the settings in the **PLAY X:** field. For details refer to "TRIM Mode" section.

Fine Adjustment of the Loop Points

Select the **To:** field in the LOOP screen and press OPEN WINDOW to open the Loop To fine window.



- **To:**
This sets the beginning of the loop. Change the value with the DATA wheel. You can enter large numbers by entering a number with the numeric pad and then pressing ENTER.
- **Ln9th:**
This sets the length of the loop. Change the value with the DATA wheel. You can enter large numbers by entering a number with the numeric pad and then pressing ENTER.
- **Loop Ln9th:**
This fixes the point of either the end point or the length of the loop.
 - VARI When the point where the loop folds is changed, the end point remains fixed and the length of the loop changes.
 - FIX When the point where the loop folds is changed, the length of the loop remains fixed and the end point moves.

Select the **Ln9th: / End:** field in the LOOP screen and press OPEN WINDOW to open the Loop End fine window.



- **End:**
This sets the end of the loop. Change the value with the DATA wheel. You can enter large numbers by entering a number with the numeric pad and then pressing ENTER.
- **Ln9th:**
This sets the length of the loop. Change the value with the DATA wheel. You can enter large numbers by entering a number with the numeric pad and then pressing ENTER.
- **Loop Ln9th:**
This fixes the point of either the end point or the length of the loop.
 - VARI When the end point is changed, the point where the loop folds remains fixed and the length of the loop changes.
 - FIX When the end point changed, the length of the loop remains fixed and the point where the loop folds moves.

You can enlarge or reduce the sample wave display by pressing **ZOOM+** [F3] or **ZOOM-** [F2]. Press **ZOOM-** [F2] to display the entire wave and set a rough point where the loop folds or the loop length then press **ZOOM+** [F3] several times to make fine adjustments.

When **PLAY X** [F6] is pressed, you can play back the currently selected sound at full velocity according to the settings in the **PLAY X:** field. For details refer to "TRIM Mode" section

ZONE mode

The ZONE mode allows you to divide a sample into a number of equal parts (from 1 to 16). This could be useful, for example, if a 2 bar sample has 4 beats to a bar: dividing the sample into 8 would give you 8 zones of 1 beat each.

Hold SHIFT and press TRIM (or 5 on the numeric pad), then press ZONE [F3].

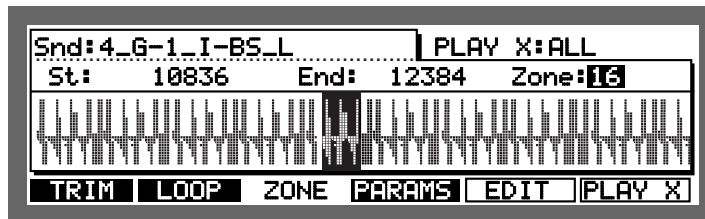

Select the Zone # field with the CURSOR keys and press OPEN WINDOW.

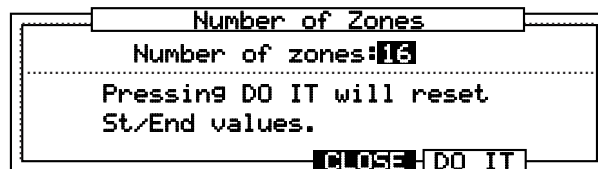

Set the number of zones with the DATA wheel.

Press DO IT [F5] to return to the ZONE screen.

You can select each zone by turning the DATA wheel while in the Zone # field of the ZONE screen.

Each individual zone can be edited from the EDIT mode (see the EDIT mode section).

Fine Adjustment of the Start Point of a Zone

Select the St. # field in the ZONE mode screen and press OPEN WINDOW to open the Zone start fine window.



- **Start#**
Set the start point of the zone. Change the value with the DATA wheel. You can enter large numbers by entering a number with the numeric pad and then pressing ENTER. You can also enter numbers with the CURSOR LEFT/RIGHT keys while holding the SHIFT key.

Note: If you adjust the start point, the end point of the previous zone will also change.

- **Ln9th#**
The length of the zone (from the start point to the end point) is displayed. You cannot change the value of this field.

You can enlarge or reduce the sample wave display by pressing ZOOM+ [F3] or ZOOM- [F2]. Press ZOOM- [F2] to display the entire wave and set a rough start point then press ZOOM+ [F3] several times to make fine adjustments.

When PLAY X [F6] is pressed, you can play back the currently selected sound at full velocity according to the settings in the PLAY X# field. For details refer to the "TRIM Mode".

Fine Adjustment of the End Point of a Zone

Select the **End#** field in the ZONE mode and press OPEN WINDOW to open the Zone end fine window.

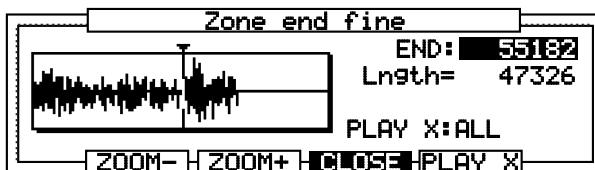

- **End#**
Set the end point. Change the value with the DATA wheel. You can enter large numbers by entering a number with the numeric pad and then pressing ENTER. You can also enter numbers with thw CURSOR LEFT/RIGHT keys while holding the SHIFT key.

Note: If you adjust the end point, the start point of the next zone will also change.

- **Ln9th=**
The length of the zone (from the start point to the end point) is displayed. You cannot change the value of this field.

You can enlarge or reduce the sample wave display by pressing ZOOM+ [F3] or ZOOM- [F2]. Press ZOOM- [F2] to display the entire wave and set a rough start point then press ZOOM+ [F3] several times to make fine adjustments.

When PLAY X [F6] is pressed, you can play back the currently selected sound at full velocity according to the settings in the PLAY X# field. For details refer to the "TRIM Mode".

EDIT Mode

This allows you to edit the sample selected in the TRIM, LOOP or ZONE window. From the TRIM, LOOP or ZONE screens, you can carry out various editing features by pressing EDIT [F5].

By turning the data wheel when the cursor is in the Edit# field, the following edit modes can be selected.

◆ DISCARD

This discards the unused sounds before the start and after the end of the selected range. Press DO IT [F5] to execute.



◆ LOOP FROM START TO END

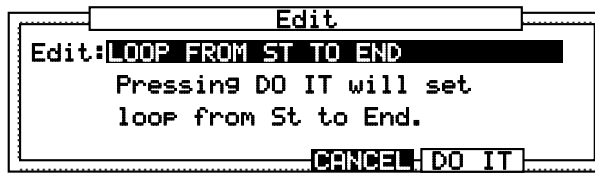

Sets the loop from start to end of the selected range.
Press DO IT [F5] to execute.

◆ SECTION ► NEW SOUND

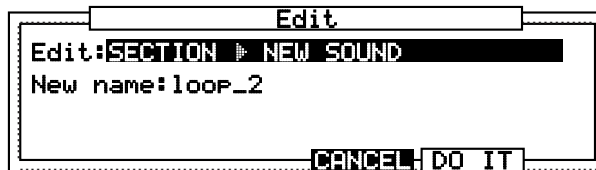

This creates a new sound by copying the range selected.
Set the sound name in the New name: field and press DO IT [F5] to execute.

◆ INSERT SOUND ► SECTION START

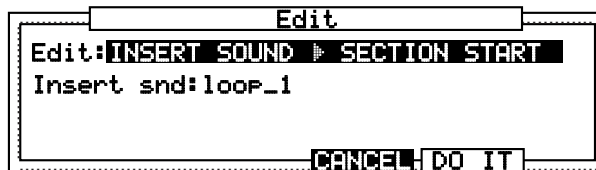

This inserts other sounds to the start point of the range selected.
Select the sound you want to insert in the Insert Snd: field and press DO IT [F5].

◆ DELETE SECTION

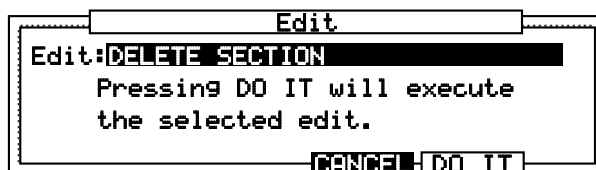

This deletes the range selected and moves the data after the end point towards the start point.
Press DO IT [F5] to execute the DELETE SECTION command.

◆ SILENCE SECTION

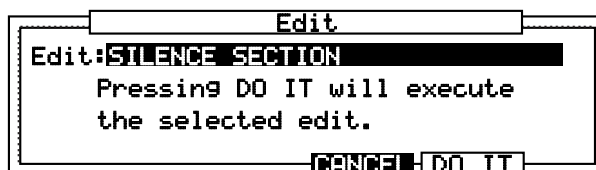

This erases and silences the range selected.
Press DO IT [F5] to execute the SILENCE SECTION command.

◆ REVERSE SECTION

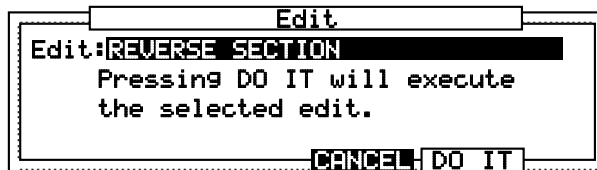

This reverses the range selected.
 Press DO IT[F5] to execute the REVERSE SECTION command.

◆ TIME STRETCH

Time stretch uses preset algorithms to lengthen or shorten a sample. This is useful when you want to match one sample to another (even though they have different tempos), to fit a sample into a specific period of time or into a track.

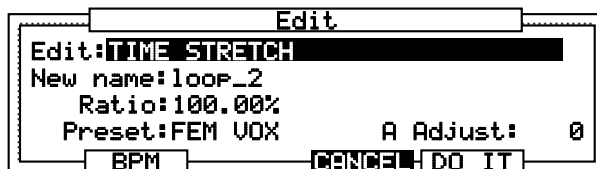

New name:

Enter a new name for the sample here.
 Tap a drum pad or rotate the DATA wheel to display the name window.

Enter the new name and press ENTER.

Ratio:

Enter the ratio of timestretch here - between 50% (twice the speed) and 200% (half the speed), 100% being the original speed. A range of plus or minus 10% gives the best results, larger settings may produce unwanted effects.

Preset:

The MPC2000XL uses 18 preset algorithms to carry out the timestretch process, so you should select a preset that nearest resembles your sample's content. If the results are not so good, try experimenting with different presets.
 Each preset is further divided into A, B or C:
 A = Standard quality timestretch with fast processing
 B = Better quality timestretch with slower processing
 C = Highest quality timestretch with slower processing

Timestretch Presets:

- | | |
|-----------------|-----------------|
| 1. FEM VOX | 10. STACCATO |
| 2. MALE VOX | 11. LFREQ SLOW |
| 3. LOW MALE VOX | 12. MUSIC 1 |
| 4. VOCAL | 13. MUSIC 2 |
| 5. HFREQ RHYTHM | 14. MUSIC 3 |
| 6. MFREQ RHYTHM | 15. SOFT PERC. |
| 7. LFREQ RHYTHM | 16. HFREQ ORCH. |
| 8. PERCUSSION | 17. LFREQ ORCH. |
| 9. LFREQ PERC. | 18. SLOW ORCH. |

Adjust:

You can use this to 'tweak' the selected preset. If the selected preset gives near enough a good result, but you feel it may benefit from a little fine tuning, try a few different settings here until you get the best result.

A positive value will help improve high frequency and percussive sounds while a negative value will help improve bass sounds.

Most of the time, this can be left at zero.

Press **DO IT** [F5] to execute timestretch.

BPM Match

This enables you to change the tempo of the sample so that it will fit into the track that you are working with.

Press **BPM** [F2] on the Timestrech screen, the B.P.M. Match screen will appear.

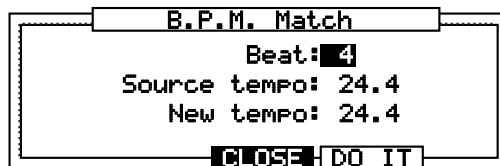

Beat:

Set the full beat length of the sample here. For example, if there are 2 bars at 4 beats to a bar, set this to 8.

Source tempo:

This is set automatically when the beat field is set. If you know the tempo of the sample, you can enter it here.

New tempo:

Set the new tempo here.

Press **DO IT** [F5] to execute tempo change.

◆ SLICE SOUND

This edit option is only available from the ZONE screen.

After you have divided a sound into zones, you can use this mode to make each individual zone into a new sample. You can also create a new program containing these samples where each sample will be assigned to 16 drum pads.

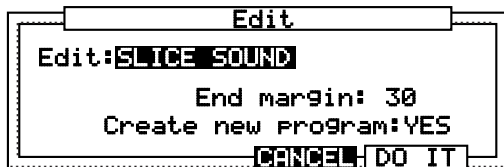

- **End margin:**
This sets how much samples will be added to at the end of each sample. As the last portion of the sample will be diminished by the decay envelope when played with a pad, it is necessary to make the sample longer to play the section fully. The original sample name with suffixed number will be used as the new sample name.

Note: No sample is added to the last ZONE.

- **Create new program:**
Set to YES if you want to create a new program containing the individual samples (each sample will be assigned to each of the 16 drum pads). The program name will be the same as the original sample name.
Set to NO if you do not want to create a new program.

Press DO IT [F5] to execute Slice Sound.

Setting the Sound Parameters

This is for setting sound parameters such as the volume or pitch of the sound. It is also possible to set the BEAT LOOP FUNCTION.

Holding SHIFT and press TRIM (or 5 on the numeric pad) and display the sound parameter screen by pressing PARAMS [F4].

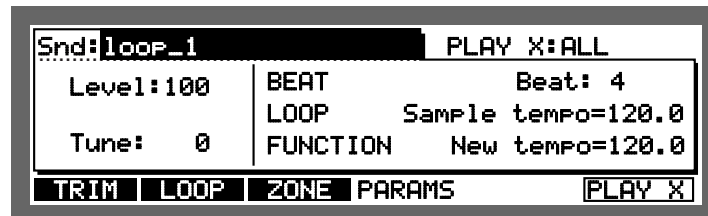

- **Snd:**
Use the DATA wheel to select the sound whose parameters you want to set.
- **Level:**
Sets the volume of the sound. Set the value with the DATA wheel or use the numeric pad to enter the number and then press ENTER.
- **Tune:**
Sets the pitch of the sound. Changes made here will also change the length of the sound.

When PLAY X [F6] is pressed, you can play back the currently selected sound at full velocity according to the settings in the PLAY X: field. For details refer to the "TRIM Mode".

Beat Loop Function

You can set the BEAT LOOP FUNCTION in the right-hand section of the Sound Parameter Screen.

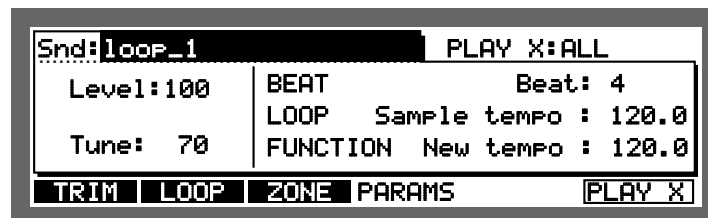

The BEAT LOOP FUNCTION is used to match the tempo of two phrase samples playing in a loop. Phrases will start to slip out of sync when multiple phrase samples playing in a loop are played back at different tempos. In order to solve this, it is necessary to change the pitch of each sample to match the tempos.

Since the Beat Loop function calculates the loop bar length, this setting does not effect one-shot (non-looped) sounds.

- **Beat:**
Set the length of the looped phrase sample here (number of beats). For example, in a four beat sample piece, if the length is four beats (one bar), enter 4.
- **Sample tempo:**
This is related to the length of the sample. The original tempo of the sample is calculated from the length of the sample and the number of beats set in the Beat: field.
- **New tempo:**
The tempo of the sound is determined by the tune settings on the left. To match the tempo with other sounds, refer to this field as you set the Tune: field on the left. To make the tempo of the two phrases match, set the value of the New tempo: of each phrase sample to be the same by adjusting the Tune: setting.



Chapter 7

Creating and Editing Programs

What Are Programs?

A program is a collection of sounds assigned to 64 note numbers (notes 35-98). You can set the envelope and filter for each note number individually and create up to 24 programs. Four programs can be played back at the same time.

A sound can only be played back (using the drum pads or MIDI keyboard) when it is assigned to a note number in a program. For example, when note number 36 is assigned to pad A02 (pad bank A/pad 2), you can play a snare drum from this pad by assigning a snare drum sound to note number 36.

The preset note numbers for the drum pads are as follows:

PAD A	PAD B	PAD C	PAD D
Pad 1-16 = 35 - 50	Pad 1-16 = 51 - 66	Pad 1-16 = 67 - 82	Pad 1-16 = 83 - 98

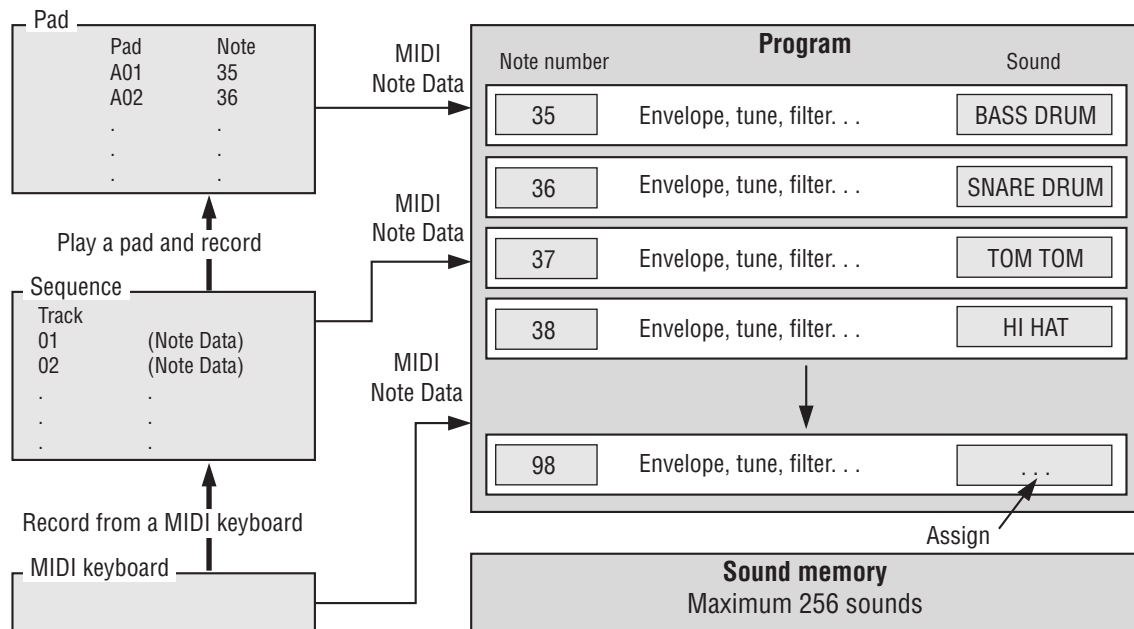

To play the pad like a rhythm machine and record the drum pattern, you can record the timing of the pad being played as sequence data by changing to sequence record mode and playing the pad. Here, the note number assigned to the pad will be played as a sequence instead of the original pad data. When the sequence is played back, the sound corresponding to the notes recorded on the track will play. (If a snare drum is assigned to note number 36, the snare drum will sound to the timing of the recording of notes 36 when the sequence is played.)

By selecting program in the PROGRAM mode, it is possible to instantly switch the program. Also, it is possible to switch using MIDI program change data.

CAUTION: *All program data will be lost when you turn the power off, so be sure to save wanted programs to disk.*

The following shows how data is organized within programs:

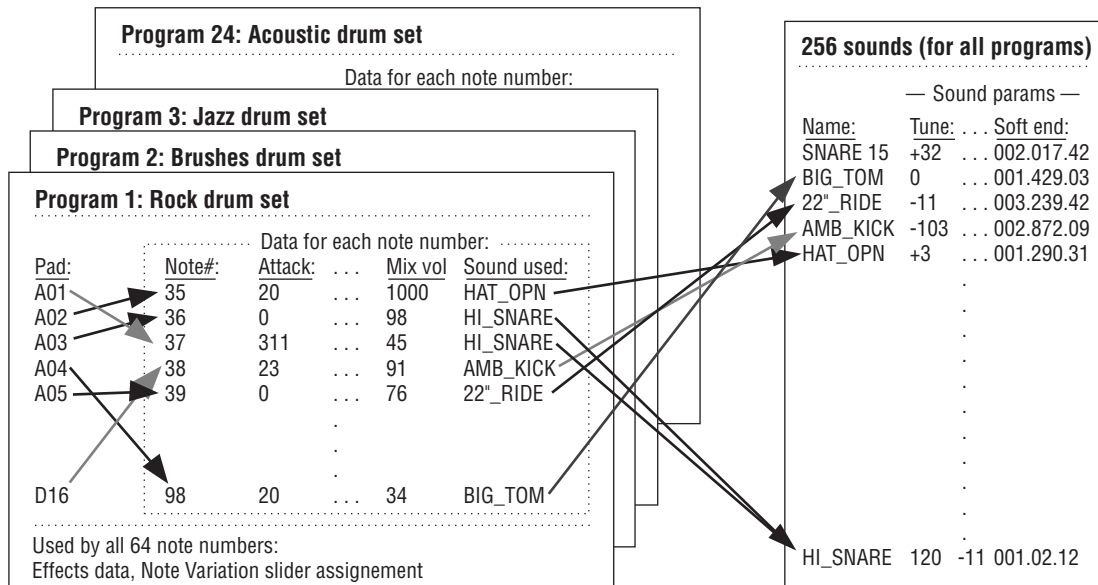

Creating a program

Hold down SHIFT and press PROGRAM (6 on the numeric keypad), the "DRUM 1-4" select screen will appear. As four programs can be played back at the same time, you can select which of the programs ("DRUM 1 - 4") you want to edit. If you are only playing back one program, select DRUM 1.

1-NEW PROGRAM A will be displayed in the Pgn# field. If there are programs stored in the MPC2000XL, you can select a program by moving the cursor to this field and rotating the DATA wheel.

To create an entirely new program, use the displayed 1-NEW PROGRAM A and assign sounds to/edit this program.

To create programs:

- ① Load the sounds from disk (or sample the sounds) that you intend to use in the program. (Refer to chapters "Creating and Editing Sounds" and "Disk Operation.")
- ② Hold down SHIFT and press PROGRAM (6 on the numeric pad) to display the Program Edit screen.
- ③ Select from "DRUM 1 - 4" (F1 - F4).
- ④ Assign a note number to the drum pad. If you are not playing the MPC2000XL from a MIDI device, such as a MIDI keyboard, the default settings can be used.
- ⑤ Assign a sound to the note number. This assigns the sound to the drum pad.
- ⑥ Press PARAMS [F2] and display the parameter screen and set the parameters of the sound.
- ⑦ Hold down SHIFT and press MIXER (7 on the numeric pad) to display the Mixer screen and set the volume or pan of the sound. If you have installed the optional 8 Assignable Mix out or effect boards, you can set them here also.
- ⑧ **SAVE THE COMPLETED PROGRAM TO A DISK.**

Selecting a Program and Assigning a Sound

There are five screens in program edit mode and the following are the functions:

1. **Assign Screen** Assigns a note number to the pad, and a sound to the note number.
2. **Parameter Screen** Edits the tone using the envelope, filter, etc.
3. **DRUM screen** To select "DRUM 1 - 4" and for MIDI setup of the internal sampler.
4. **PURGE screen** To erase all unused sounds (sounds not assigned to programs) from memory.
5. **AUTO screen** To automatically assign sounds in semi-tone steps to the 64 drum pads (PAD A01 - D16) – note range 35 - 98 on a MIDI keyboard.

Hold down SHIFT and press PROGRAM (numeric key 6), then select "DRUM 1-4". This first screen is the "ASSIGN" screen for assigning sounds to a program.

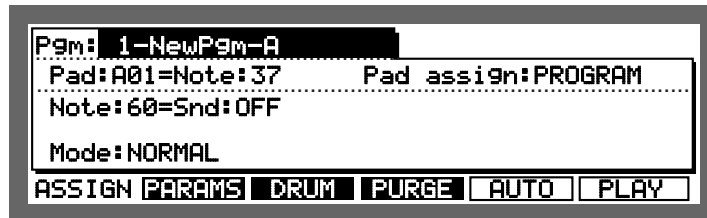

You can listen to the selected sound at its full velocity by pressing PLAY [F6].

Selecting Programs

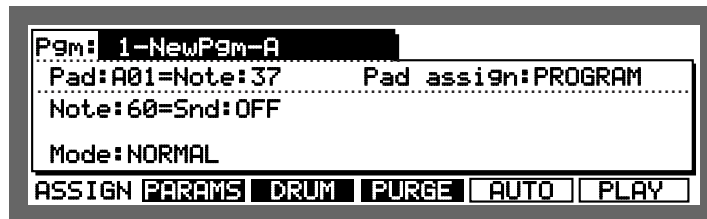

Move the cursor to the Pgm: field and select a program by rotating the DATA wheel. The program number and program name will be displayed.

CAUTION: If there are no other programs saved or loaded, turning the DATA wheel will have no effect.

Renaming Programs

Open the Program screen, select the Pgm# field and press OPEN WINDOW.



- **Program name:**
This changes the name of the program.
Tap a drum pad or rotate the DATA wheel to display the name window.

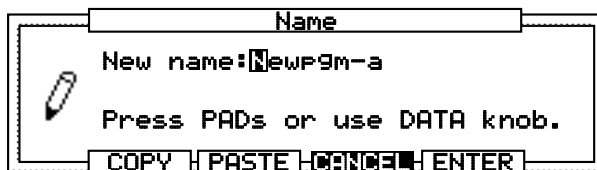

Enter a name and press ENTER [F5] to confirm.

Note: If you do not press ENTER [F5] and move to other pages, the entered name will be ignored and the name will not change.

- **MIDI program change:**
This sets the program change number. You can switch the program by sending program changes from external MIDI devices.

Deleting a Program

Open the Program screen, select the Pgm# field and press OPEN WINDOW.

The Delete Program window will open if you press DELETE[F2].

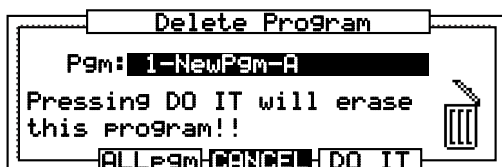

Select the program you want to delete in the Pgm# field and press DO IT [F5] to delete the selected program.

When ALLPgm [F3] is pressed, the following warning window will appear and all of the programs will be erased when DO IT [F5] is pressed.

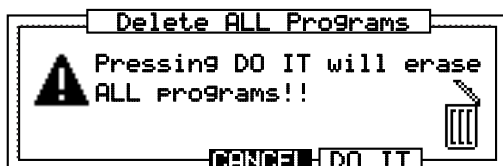

Creating New Programs

Open the Program screen, select the Pgm#: field and press OPEN WINDOW.

The Create New Program window will open if you press NEW[F3].



- **New name:**
This sets the name of the program. Refer to “Renaming a Program” on how to enter characters.
- **MIDI program change:**
This sets the program number.

Copying Programs

Open the Program screen, select the Pgm#: field and press OPEN WINDOW.

Press COPY [F5] to open the Copy Program window.

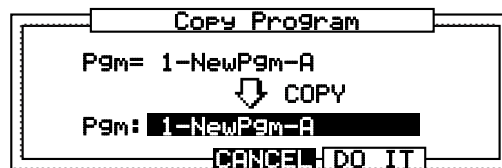

Select the program that you want to copy the data to with the DATA wheel.

Press DO IT [F5] to copy the program data.

CAUTION: *If there is data in the program you have selected as the destination, the data will be erased when you press DO IT. Be careful when you are copying to a program with a name other than “no program.”*

Assigning Notes to the Drum Pads

The preset note numbers for the drum pads are as follows:

PAD A	PAD B	PAD C	PAD D
Pad 1-16 = 35 - 50	Pad 1-16 = 51 - 66	Pad 1-16 = 67 - 82	Pad 1-16 = 83 - 98

You can assign different note numbers if you want to.

From the Program screen, select the Pad#: field with the CURSOR keys and select a drum pad that you want to assign a note to with the DATA wheel or by hitting one of the drum pads.

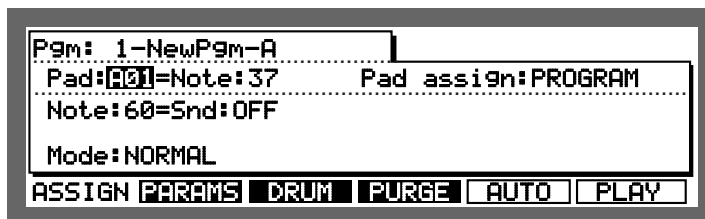

Select the Note# field on the right by pressing CURSOR RIGHT key and set the note number with the DATA wheel.

You can change this field by playing a drum pad when the cursor is in this field. This way, you are able to assign notes continuously without moving the cursor.

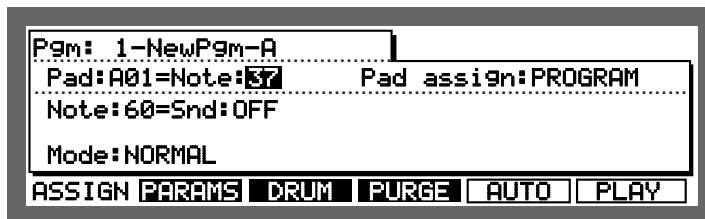

You can display a list of the notes assigned to the drum pads by selecting the Pad# or Note# field and pressing OPEN WINDOW .

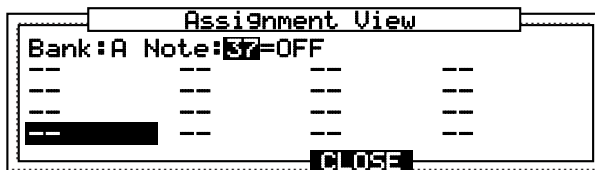

Select a drum pad with the CURSOR key or by hitting the drum pad. The note number assigned to that selected pad is displayed at the top of the screen.

Assigning Sounds to Notes

This assigns sounds to note numbers.

Select the **Note#** field with the CURSOR keys and select the note number that you want to assign with the DATA wheel.

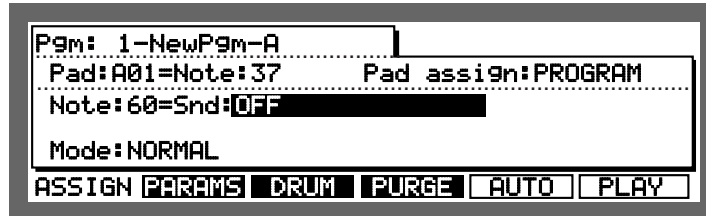

Select the **Snd#** field by pressing the CURSOR RIGHT key and select the sound you want to assign by rotating the DATA wheel.

When the value in the pad field is changed, the note number assigned to that pad will automatically appear in the **Note#** field .

When the cursor is in the **Snd#** field, it is possible to change the **Pad#** field by playing one of the pads. When the **Pad#** field is changed, the **Note#** field will also automatically be changed. This way, you can continuously set the sound assignments without moving the cursor.

When the cursor is in the **Snd#** field, pressing OPEN WINDOW displays the Sound window to show the relevant information. Please refer to Creating and Editing Sounds for details.

Auto Chromatic Assignment

To automatically assign sounds in semi-tone steps to the 64 drum pads (PAD A01 - D16) – note range 35 - 98 on a MIDI keyboard.

Hold SHIFT and press PROGRAM (numeric key 6), select DRUM 1– 4 and press AUTO [F5].

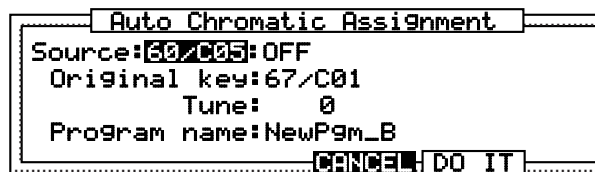

In the **Source** and **Original key** fields, the display characters show the MIDI note number and drum pad number: 60/C05 is MIDI note 60/pad bank C, drum pad number 5.

- **Source#**
Select the sound and MIDI note number to be assigned here. You can select the sound with the drum pads or the DATA wheel (the name of the sound also appears).
Note: The parameters of the sound selected here will be copied to each note.
- **Original key#**
Select the note on the MIDI keyboard/drum pad which will play the original pitch of the sound.
- **Tune#**
To apply offset to the original pitch. This setting will affect each note.

- **Prog name:**
Tap a drum pad or rotate the DATA wheel to display the name window.
Input the name and press ENTER [F5] to save the new name.

While this window is open, the program can be played according to the parameters assigned.

Press DO IT [F5] when you have finished entering all the data.

The Pad Assign / Initialize Pad Assign Modes

Select the pad assign mode in the Pad assign# field.

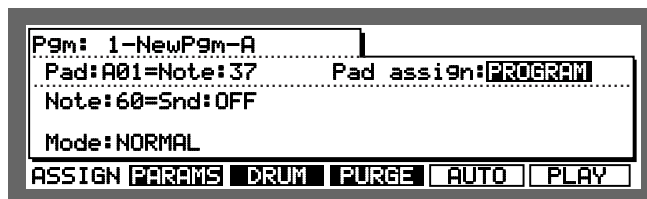

Pad assign# field, the pad assignment is stored as the master assign and can be adapted to other programs.

- PROGRAM Stores the pad assigns for each individual program.
- MASTER Adapts the master assign to this program.

CAUTION: The master pad assign can be changed from any program when MASTER is displayed in the Pad assign# field, but note that the change will effect all the programs set to MASTER.

To initialize a pad assign, select the Pad assign# field and press the OPEN WINDOW key.

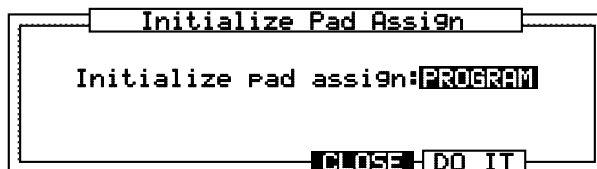

The pad assign of the currently selected program will be initialized if you select PROGRAM with the DATA wheel. By selecting MASTER, the master assign is initialized and all the programs set to MASTER are initialized.

To initialize, press DO IT [F5].

Deleting unused sounds from the memory

You can delete all unused sounds (sounds not assigned to programs) from memory.

Press PURGE [F4].

The number of sounds not being used by the programs is displayed at the bottom of the message.

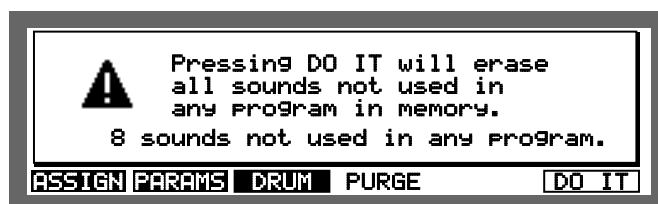

Press DO IT [F6] to delete the unused sounds.

The Program Sound Generation Mode

By setting the sound generation mode, you can generate up to three sounds simultaneously or switch the sound by using velocity and decay.

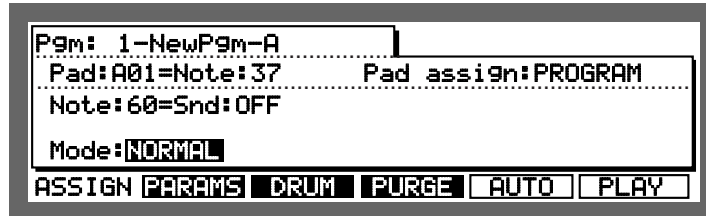

Select the **Mode:** field with the CURSOR keys and select from the following four modes with the DATA wheel.

NORMAL

Only the sound in the **Snd:** field plays when the selected MIDI note number is received.

SIMULT

This plays up to three sounds together each time the note number specified in the **Note:** field is received. When this option is selected, two **Also play note:** fields appear to the right of the **Mode:** field. Select the notes that you want to play simultaneously with the DATA wheel. If you only want to add one sound, select either field and rotate the DATA wheel to the left until ---/OFF is displayed. The following example generates a sound assigned to 36/A02 and 53/A16 over a sound assigned to MIDI note number 60.



VEL SW

The sound assigned to the program and the two sounds set here can be switched with strong or weak velocity. When this option is selected, two **If over:** fields appear to the right of the **Mode:** field. When the velocity of the drum pads or the MIDI note on exceed these settings, the generated sound will switch. To switch between only two sounds, select either field and rotate the DATA wheel to the left until ---/OFF is displayed. The following example generates the sound of MIDI note number 60 up to velocity 44 and 36/A02 between velocity 45 and 88, and 53/A16 over velocity 89.

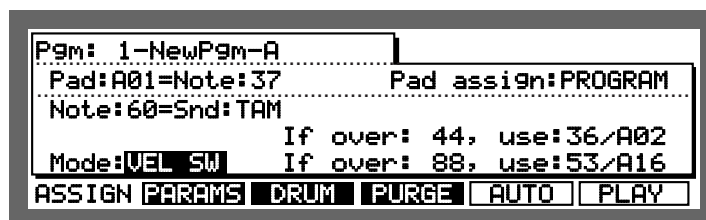

DCY SW

This switches between the sound assigned to the program and the two sounds set here using the value set in the Decay field (see following pages). When this option is selected, two If over: fields appear to the right of the Mode: field. Set the decay value and note here. In the following example, the sound assigned to the selected note number generates MIDI note number 60 up to decay 44, 36/A02 between decay values 45 to 88, and 53/A16 for velocity over 89.

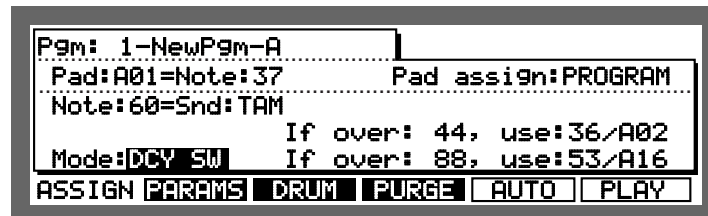

Normally the DECAY is assigned to the NOTE VARIATION slider and is used to switch the sound by changing the decay parameter with the NOTE VARIATION slider. For example, by using this as a hi-hat sound, you can switch between closed, half, and open sounds effectively.

Editing Note Parameters

This edits the note parameters assigned to the program.

Hold down SHIFT and press PROGRAM (6 on the numeric keypad) to display the program assign screen and press PARAMS [F2] to display the parameter screen. Pressing PARAMS [F2] again, displays the DRUM 1-4 select screen.

Selecting Programs

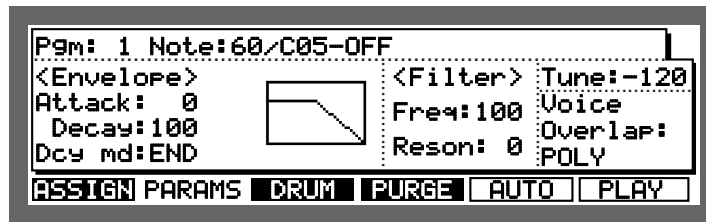

Move the cursor to the Pgm #: field and select a program by rotating the DATA wheel.

You can rename, delete, copy, or create new programs using the Program window in the same way as the Assign screen. Please refer to page 113.

Selecting Notes

You can select the sound of the tone that you want to edit.

Select the Note#: field with the CURSOR keys and select the note you want to edit with the DATA wheel or by hitting the drum pad. The assigned sound name appears to the right of the note number.



Copying the Note Parameter

The various settings you make on the parameter screen effect the note number. When a complicated edit is made on a note and you want to use this edit on another note, you can copy the note parameters to another note.

To open the Copy Note Parameters window, select the `Note#` field and press OPEN WINDOW.

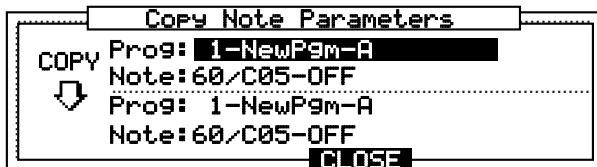

In the upper part of the window, use the DATA wheel to select the program and the note number of the sound you want to copy.

In the lower part of the window, use the DATA wheel to select the program and the note number that you want to copy to.

Copy the note parameters by pressing `DO IT [F5]`.

Setting the Envelope

This edits the envelope of the sounds assigned to each note.

The envelope has three parameters. Select the parameter that you want to edit with the CURSOR keys and set the number with the DATA wheel.



- **Attack:**
This sets the attack time of the envelope. This is usually set to 0 for drum sound sources. The higher the value, the slower it sounds.
- **Decay:**
This sets the decay time of the envelope. The larger the value the milder the sound decays.
- **Dcy md:**
This sets the type of decay.

END The decay ends at the end of the sample. The starting point of the decay is determined by the settings in the `Decay#` field. This is convenient in smoothly fading out the end of a sound.

Also, when a sample is looped, the sample will decay according to the settings in the `Decay#` field after note off. (Here, the settings in the `Voice overlap#` field is overridden by NOTE OFF. See page 126)

START The decay starts after the attack time.

CAUTION: When the sample is short, the decay time will have higher priority than the attack time.

While one of the envelope fields is selected, press OPEN WINDOW to display the following window.



You can set the ratio in which the envelope or volume changes according to the velocity.

- **Velo▶Attack:**
This allows the velocity to control the attack time. The larger the value, the shorter the attack time becomes with the impact of the velocity. When this is set to 0, the attack is the same regardless of the velocity.
- **Velo▶Start:**
This allows the velocity to control the starting point of the sample. The larger the value, the slower the start of the sample becomes as the velocity is weaker. When this is set to 0, the start is the same regardless of the velocity.
- **Velo▶Level:**
This allows the velocity to control the volume. The larger the value, the louder the sample becomes with the impact of the velocity. When this is set to 0, the volume is the same regardless of the velocity.
- **Velo:**
This field displays the velocity in real-time when the drum pad is hit.

Setting the Filter

This edits the filter of the sound assigned to each note.

The filter has two parameters that you can edit. Select the parameter field you want to edit with the CURSOR key and set the value with the DATA wheel.

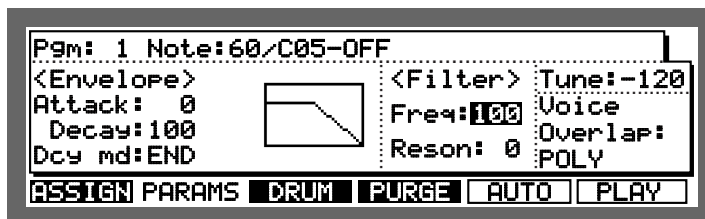

- **Freq:**
This sets the cut off frequency of the filter. The smaller the value, the darker the sound becomes.
- **Reson:**
This sets the resonance of the filter. The larger the value, the more emphasized the boarder of the cut off frequency is, creating a unique sound.

While one of the filter fields is selcted, press OPEN WINDOW to display the following window.



Set the ratio in which the filter changes according to the settings of the filter envelope and velocity here.

- **Attack:**
This sets the attack time of the filter envelope. The larger the value, the more time it takes for the sound to clarify.
- **Decay:**
This sets the decay time of the filter envelope. The larger the value, the softer the decay of the cut off frequency becomes.
- **Amount:**
This sets the depth of the filter envelope. The larger the value, the larger the effect of the filter envelope becomes. The envelope is disabled when it is set to 0.
- **Velo*Freq:**
This allows the velocity to control the filter. The larger the value, the clearer the sound becomes with the impact of the velocity. When this is set to 0, the tone is the same regardless of the velocity impact.
- **Velo:**
This displays the velocity in real time when the dum pad is hit.

Setting the Pitch

This sets the pitch of the sound assigned to each note.

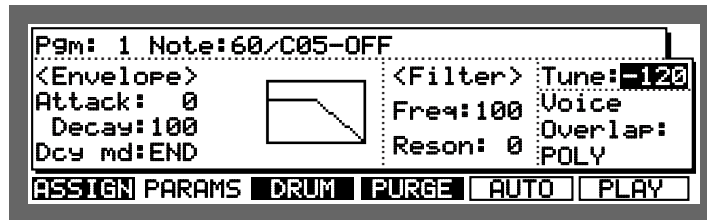

Select the **Tune:** field with the CURSOR keys and enter the number with the DATA wheel. You can enter numbers directly with the numeric pad. In this case press ENTER after you have entered the number.

Select the **Tune:** field and press OPEN WINDOW.



- **Tune:**
This is the same as the **Tune:** field on the previous screen.
- **Prog tempo:**
How much the sample's tempo, set in the trim mode, has been changed by the tune set above will be displayed. The value can not be changed here.
This is convenient when matching the tempo of the phrase sample of a drum loop etc..
- **Velo▶Pitch:**
This allows the velocity to control the pitch. The larger the value, the higher the pitch becomes with the velocity impact. When this is set to a negative value, the pitch becomes lower as the velocity impact increases. When this is set to 0, the pitch does not change regardless of the velocity impact.
- **Velo:**
This displays the velocity value in real-time by hitting the drum pad.

Setting the Voice Overlap

When the same note is generated repeatedly, this can be used to set whether the previous sound is canceled or overlapped.

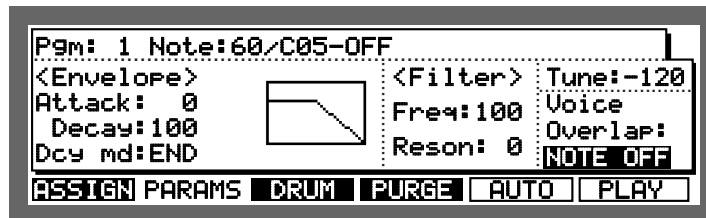

Select the **Voice Overlap:** field with the CURSOR keys and select one of the following three modes with the DATA wheel.

- POLY** Multiple plays of the sound are assigned to additional voices, allowing polyphonic overlap. This is useful for sounds like ride cymbals, for which you don't want new notes to cut off by old ones.
- MONO** Multiple plays of the sound use the same voice, terminating the previous sound and restarting playback of the sound (no polyphonic overlap). This is useful for producing stuttering effects.
- NOTE OFF** When the pad is released (or a MIDI Note Off message is received), the sound is terminated. When the **Dcy md:** field is set to END, the loop on sound is set to this mode.

While **Voice Overlap:** is selected, press OPEN WINDOW.

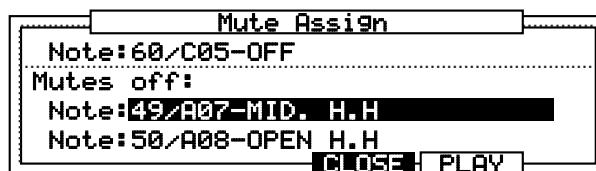

While either note set in the **Note:** field in the lower half of the display is generated, the note is muted when a note displayed in the upper half of the display is generated. This is convenient when you want to stop the sound of an open hi-hat with a closed hi-hat.

To turn this function off, select the **Mutes off: Note:** field and select **---/OFF** by rotating the DATA wheel to the left.

The MIDI Settings of the Sampler

This sets the MIDI settings of the internal sampler.

Hold down SHIFT and press PROGRAM (numeric key 6), then select "DRUM 1-4". Then press DRUM (F3). Pressing DRUM [F3] again, displays the DRUM 1-4 select screen.

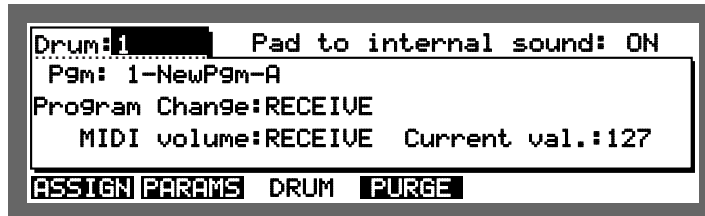

- **Program Change:**
This sets whether or not to switch the program using the MIDI program change. When RECEIVE is selected, it will switch, and when IGNORE is selected, it will not switch.
- **MIDI volume:**
This sets whether or not to receive MIDI volume data. When RECEIVE is selected, it will receive the data and when IGNORE is selected, will not receive the data.
- **Current val:**
This is the MIDI volume data value which the internal sampler last received. When the MIDI Volume: is set to RECEIVE, the volume of the internal sampler is controlled by the MIDI volume data. If the MPC2000XL receives MIDI volume 0, the sampler will not generate any sound until a larger MIDI volume is received. (The level stays at 0.) Check this field when all the other settings are correct and the sampler does not generate a sound. If the MIDI volume data received is 0 or a small value, change the value in this field to a larger value.
- **Pad to internal sound:**
This separates the connection between the internal sampler and the drum pads. Set this OFF when you are not using the sequencer function of the MPC2000XL and using the pad and sampler with another sequencer. This way the drum pad data will not go to the internal sampler and will be output from the MIDI Output. The sampler will generate sounds from external data coming in from the MIDI Input.



Chapter 8

Mixer Functions

Stereo Output Mixer

The MPC2000XL has a 64 channel stereo mixer which allows you to set the volume and pan for each of the 64 notes assigned to a program.

Hold down SHIFT and press MIXER (numeric key 7), then select "DRUM 1-4". The mixer display will appear.

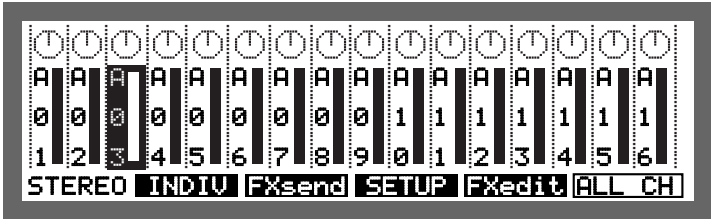

The above illustration displays the volume and pan of pad bank A (drum pads A01 – A16). To display other banks B, C or D, press the PAD BANK keys.

Setting the Volume

Select the channel that you want to adjust with the CURSOR LEFT/RIGHT key or by hitting the drum pad. If the pan icon at the top of the screen is selected, use the CURSOR DOWN key to move the cursor to the volume field.

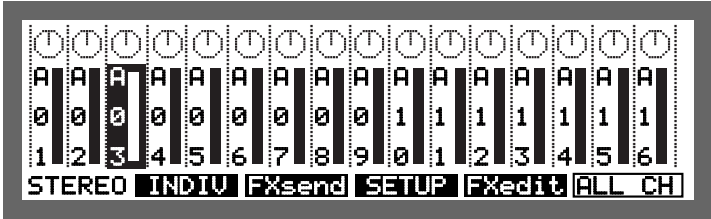

Set the volume with the DATA wheel. The volume slider display will move up and down corresponding to the value.

Setting the Left/Right Pan

Move the cursor to the Pan field at the top of the screen with the CURSOR UP key. Select the channel that you want to adjust with the CURSOR LEFT/RIGHT key or by hitting the drum pad.

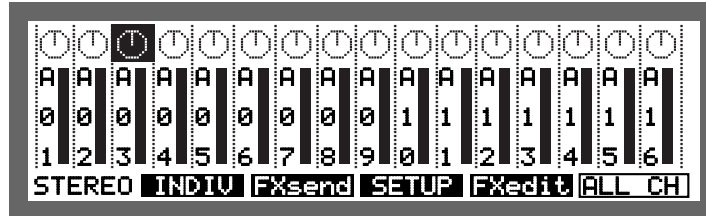

Set the pan with the DATA wheel. The pan icon rotates according to the value.

Linking the Volume/Pan Levels

This allows you to link all the channels together and adjust the volume or pan of all the channels at the same time.

Press ALL CH [F6] and select the volume or pan settings for the displayed bank. You can switch between volume and pan with the CURSOR UP or DOWN keys.

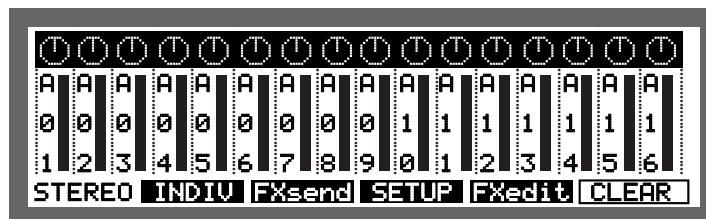
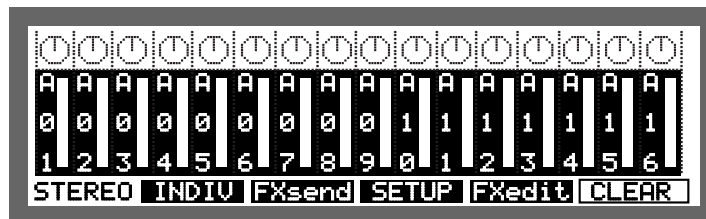

When you rotate the DATA wheel, all the channels will change at the same time.

Press CLEAR [F6] again to cancel the link mode.

Holding down SHIFT and tapping the drum pads, allows you to select multiple channels simultaneously.

Setting the Individual Outputs and Effect Send (Option)

When the optional 8 Individual Output Board (IB-M208P) or Effect board (EB16) is installed, you can set the output of the sound or the effect send from the Individual Out screen.

CAUTION: If the Individual Output Board (IB-M208P) or effect board (EB16) is not installed, changes here will have no effect.

Hold down SHIFT and press MIXER (numeric key 7), then select "DRUM 1-4".
The mixer display will appear.
Press INDIV [F2] to display the individual output screen.

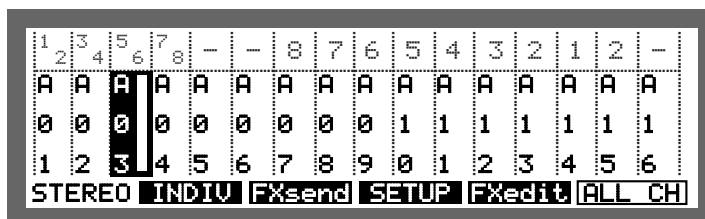

Set the output jack that the sound will be sent to at the top of the screen. Set the output level on the bottom of the screen. You can switch the banks with the PAD BANK key.

Assigning the Sounds to Individual Outputs

Move the cursor to the top of the screen with the CURSOR UP key. Use the CURSOR LEFT or RIGHT key or hit the drum pad to select the channel whose output you want to set.

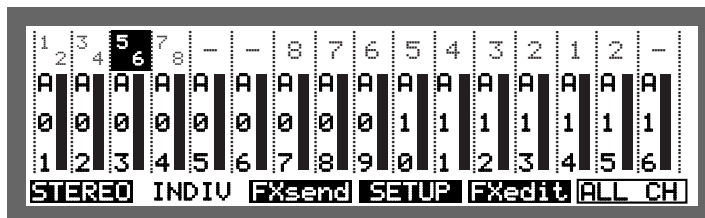

Select the output with the DATA wheel. The numbers one through eight correspond to each individual out jack on the rear panel. When the sound is in stereo, it is possible to select two digit numbers such as 1₂ or 3₄. In this case, the odd number is the left channel and the even number is the right channel (Output 1 = left / Output 2 = right).

CAUTION: If the Individual Output Board (IB-M208P) or effect board (EB16) is not installed, changes here will have no effect.

Setting the Output Level

Move the cursor to the Level field with the CURSOR DOWN key. Select the channel of that you want to adjust with the CURSOR LEFT/RIGHT key or by hitting the drum pad.

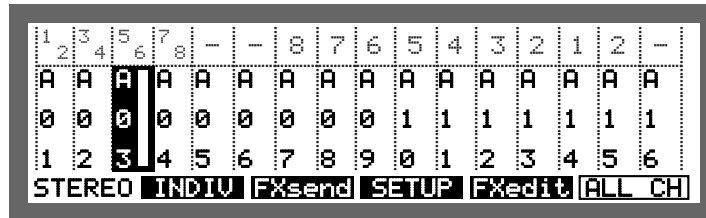

Set the level with the DATA wheel. The volume slider display will move up and down corresponding to the value.

Linking the Individual Outputs/Output Levels

This allows you to link all the channels together and adjust the output level or output assignment of all the channels at the same time.

Press ALL CH [F6] and select the output level or output assignment settings for the displayed bank. You can switch between output level or output assignment with the CURSOR UP or DOWN keys.

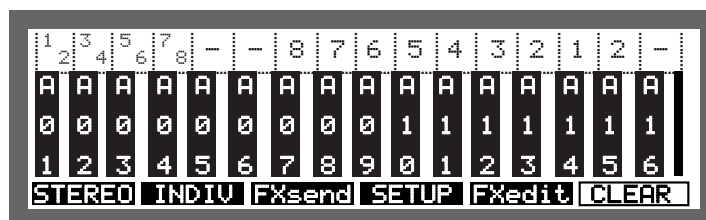
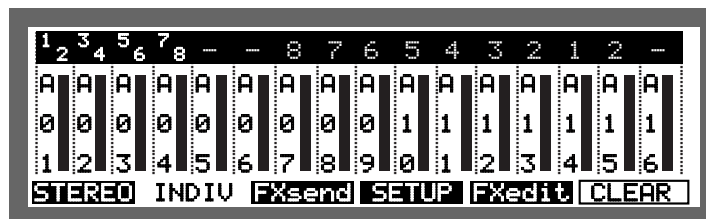

When you rotate the DATA wheel, all the channels will change at the same time.

Press CLEAR [F6] again to cancel the link mode.

Sending Effects

Effect send can only be used when the optional EB16 effect board is installed. Press FXsend (F3) to display the effect send screen.

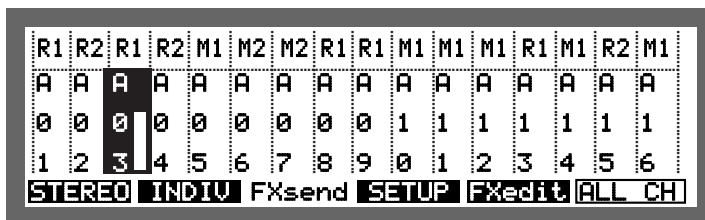

Assigning the Effect to be Used

Move the cursor to the top of the screen with the CURSOR UP key and select the channel that you want to assign an effect to (use the CURSOR LEFT/RIGHT keys or drum pads).

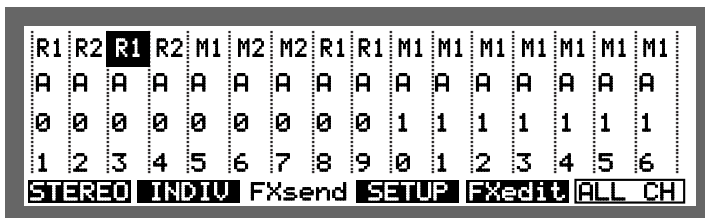

Turn the DATA wheel to select the effect that you want to use:

- M1 / M2 = Multi effects 1 or 2
- R1 / R2 = Reverb 1 or 2

Setting the Effect Send Level

Move the cursor to the lower part of the screen with the CURSOR DOWN key and select the channel whose effect send level you want to adjust (use the CURSOR LEFT/RIGHT keys or drum pads).

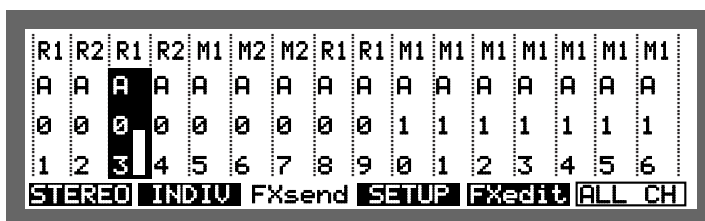

Turn the DATA wheel to adjust the level.

Adjusting all the Channel's Effect Send Levels/Effect Assign at the Same Time

By pressing the ALL CH [F6] key while in the effect send level or effect assign field, all the channels are linked together and can all be adjusted at the same time.

Press CLEAR [F6] to cancel the link mode.

Setting the Volume or Pan for Each Note

Up to this section the volume or pan settings were set by displaying them together for each pad bank. It is also possible to display a list of parameters for each note.

Hold down SHIFT and press MIXER (numeric key 7), then select "DRUM 1-4".

The mixer display will appear.

Select one of the channels with the drum pads or CURSOR LEFT/RIGHT keys, press OPEN WINDOW and the "Channel Settings" screen will appear.

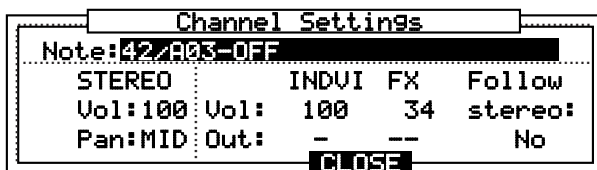

Select the Note# field with the CURSOR key and select the note you want to edit with the DATA wheel. The assigned sound name appears to the right of the note number. It is also possible to directly select by hitting the drum pad.

The left-hand part of the screen:

STEREO to set the volume and pan of the rear panel STEREO OUT outputs.

The right-hand part of the screen:

INDIV to select the individual output jack and volume level (if the optional board is installed).

FX to select an effect and set the effect send level.

Follow stereo: If set to YES, the individual out and effect send levels will be changed when the stereo output mixer level is changed.

If set to NO, the individual out and effect send levels will not be affected when the stereo output mixer level is changed.

Setting Up the Mixer

Hold down SHIFT and press MIXER (numeric key 7), then select "DRUM 1-4".

The mixer display will appear.

Press SETUP [F4] to display the mixer setup screen.

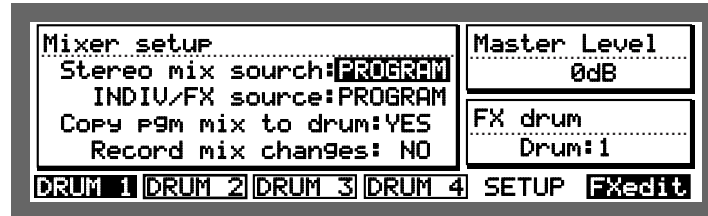

In the Stereo mix source: field set the Stereo Output mixer and in the Indiv/FX source: field set the Individual Output mixer. The following parameters can be selected for either one.

PROGRAM

When you select this mode, the mixer or individual output settings change to the settings of each program.

DRUM

This records the mixer or individual output settings within ALL PROGRAMS (the data extension when saved is .APS) which applies to all programs and sequences. When you select this mode, the mixer or individual output settings will not change when the program or sequence is modified and the DRUM settings will always be applied.

Copy on P9m mix to drum:

To COPY the mixer settings of the program to DRUM when the program assigned to drum is to be changed by Program Change.

Recording a Mixer Setting to a Sequence

Record Mix Change: enables you to record the revised mixer settings to a sequence during sequence recording.

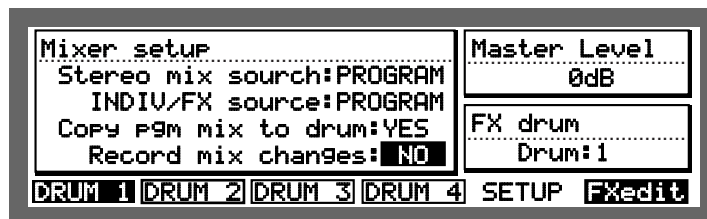

By selecting YES in this field, you can record the mixer setting changes to the sequencer. The mixing data recorded in the sequencer is displayed as follows in the Step Editing page and can be edited as another MIDI event.

STEREO LEVEL	N:64/A01	L:100	████████
STEREO PAN	N:64/A01	P:R50	████████
INDIV LEVEL	N:64/A01	L:100	████████
FXsend LEVEL	N:64/A01	L:100	████████

Mix Change data will be recorded as MIDI Exclusive. The following are the contents of the exclusive data.

F0 47 00 44 45 (Event Type) (Pad Number) (Value) F7

There are four types of events.

- 01 STEREO LEVEL
- 02 STEREO PAN
- 03 FXsend LEVEL
- 05 INDIV LEVEL

Pad numbers A01 ~ D16 correspond to 00 ~ 3F.
Value can be set between the range 00 ~ 64.

Setting the Master Level

To adjust the total output level of the MPC2000XL, use the Master Level section.

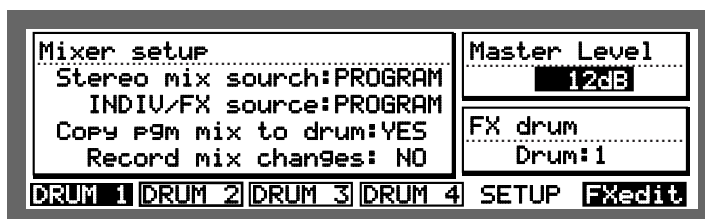

Master Level:

To set the overall level of the MPC2000XL.

The MPC2000XL can generate up to 32 sounds at one time. Therefore, there is a large difference in the output level when only one or many sounds are generated. If you play a lot of sounds at the same time, the level may be too high and the sound will be distorted. You can prevent distortion by lowering the Master Level. If you are not playing a lot of sounds at the same time, increase the level to cover noise.

FX drum

To select which of the four "DRUM 1 - 4" settings you want to use the effects with.



Chapter 9

Effects (optional)

By installing the optional effect board (EB16), you can carry out various effect processing for each sound.

Editing Effects

Hold down SHIFT and press MIXER (numeric key 7), then select "DRUM 1-4". The mixer display will appear. Press FXedit [F5] to display the effects screen.

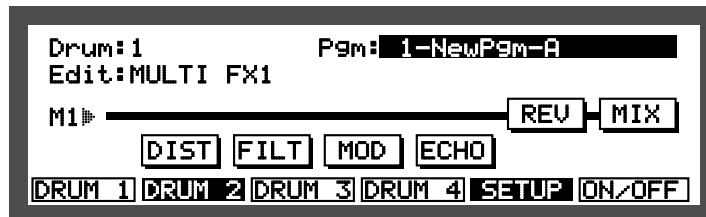

The effect board EB16 contains 2 multi-effects and 2 reverbs. The multi-effect consists of modules for each effect and each module can be edited or rearranged.

The effect settings of MULTI FX1, MULTI FX2, REVERB 1 and REVERB 2 can be set individually.

Drum#: For selection of the 4 drum programs that can be used simultaneously on the MPC2000XL. Setting the effects assigned to the selected drum program is done here.

Note: Each drum program can have its own effect setting, but only one effect setting can be used.

Pgm#: For display of the program assigned to the drum selected in the Drum# field. The program can be changed here.

Edit#: Selects the effect to be edited.

Turning Each Effect On or Off

Each multi-effect contains 5 types of effects and a MIX setting. You can turn each effect and mix setting on and off.

Use the CURSOR LEFT/RIGHT keys to select the effect that you want to turn on or off.

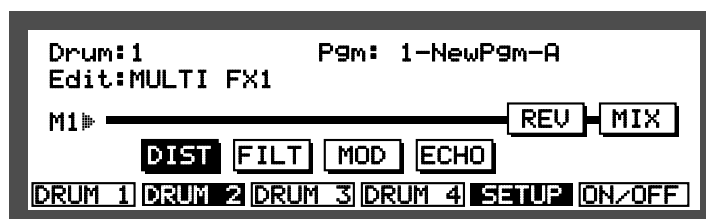

Press ON/OFF [F6] to switch between on and off.

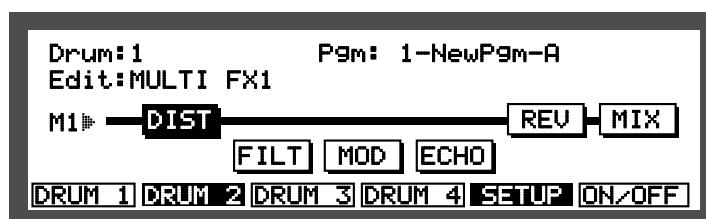

When MIX is off, all of the effect sounds will be muted regardless of the on/off status of each effect.

Multi-effects

The MPC2000XL has two multi-effects and each has five effect modules. You can execute various routings by rearranging the modules. Select MULTI FX1 or FX2 in the Edit: field of the FXedit screen and then select MIX with the CURSOR keys.

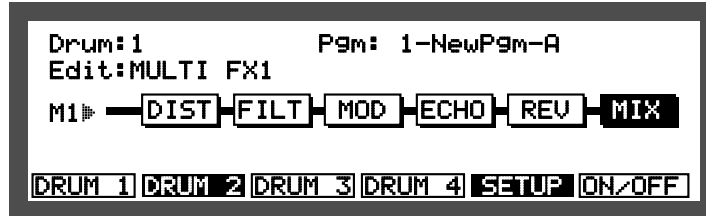

Press OPEN WINDOW to open the Effect Mixer window.

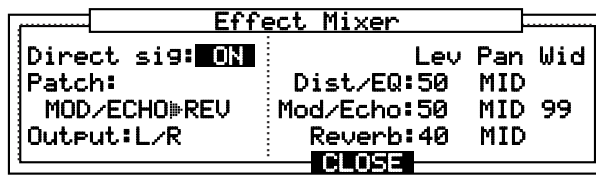

Direct sig: This turns the direct sound of the signal input to an effect on or off. When it is ON, the level or pan of the direct sound is adjusted by the stereo mixer.

Patch: To set the effect routing.

Output: To select the output of the effect (left and right or individual outputs 1/2, 3/4, 5/6, 7/8).

Dist/EQ: This sets the output level and pan of the distortion and filter modules.

Mod/Echo: This sets the output level and pan of the modulation and delay/echo modules. Wid adjusts the stereo range of the effect. When Wid is set to 0, the output effect sound becomes monaural.

Reverb: This sets the output level and pan of the reverb module.

Setting the Effect Routing

Select the routing of the multi-effect in the Patch: field.

When MOD/ECHO>REV is selected

The signal flow is as follows:

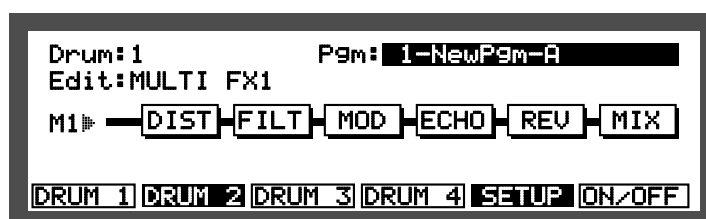
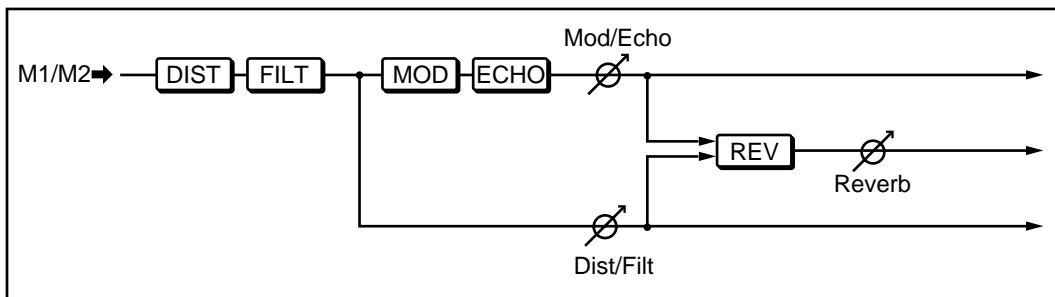

When REV►MOD/ECHO is selected
The signal flow is as follows:

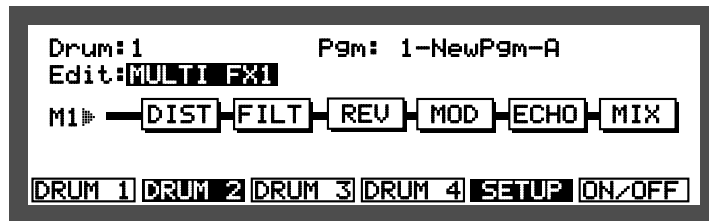
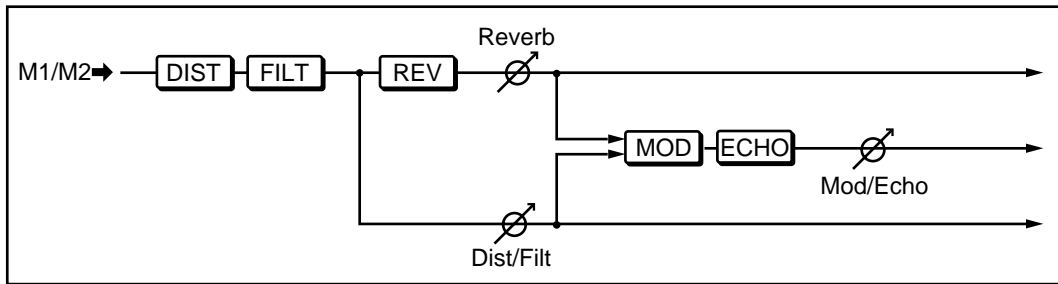

When MOD/ECHO+REV is selected
The signal flow is as follows:

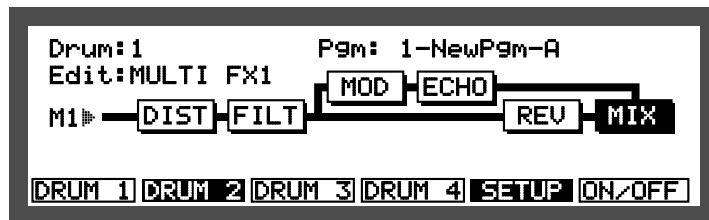
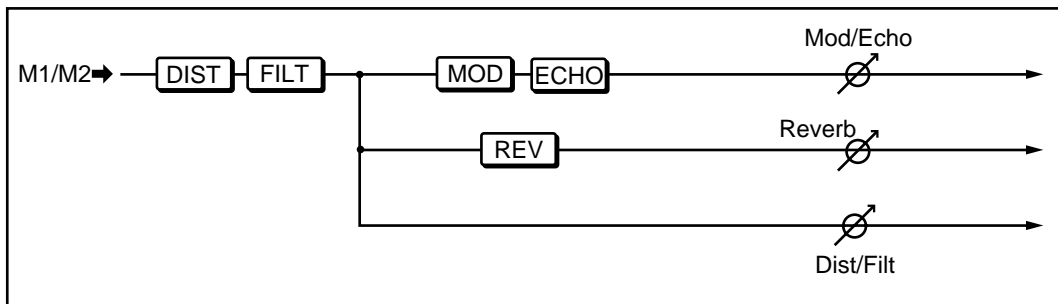

Reverb Effects

In addition to the two types of multi-effects, the MPC2000XL provides two reverb-only effects. These can be selected directly from the FXsend screen, but it is also possible to use them with the multi-effects. You can send a signal to the reverb from four points in the multi-effect. So you can use the R1(R2) reverb while M1(M2) is selected in FXsend.

The following are ways to select the way REVERB 1 and REVERB 2 are used:

Select REVERB 1 or REVERB 2 in the Edit: field and then select the Input: field with the CURSOR keys.

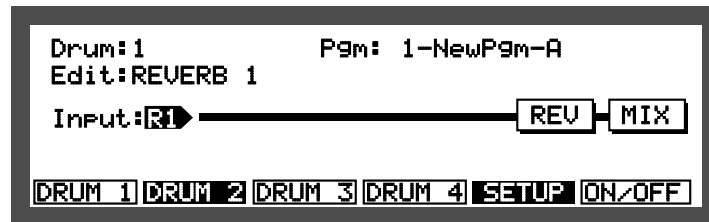

Choose the way the reverb will be used with the DATA wheel.

When R1(R2) is selected, the effect is added to the sound of the channel selected for R1(R2) in the FXsend screen.

When M1(M2) is selected, the effect is added to the sound of the channel selected for M1(M2) in the FXsend screen.

When FX1(FX2) DIST/FLT is selected, the effect is added after the sound passes through the multi-effect DISTORTION and 4-BAND FILTER.

When FX1(FX2) MOD/ECHO is selected, the effect is added after the sound passes through the multi-effect MODULATION and ECHO.

When FX1(FX2) REVERB is selected, the effect is added after the sound passes through the multi-effect REVERB.

Each patch (the effect routing selected in the Patch: field of the MIX window) of the multi-effect has a signal flow as shown in the following examples.

When MOD/ECHO ► REV is selected

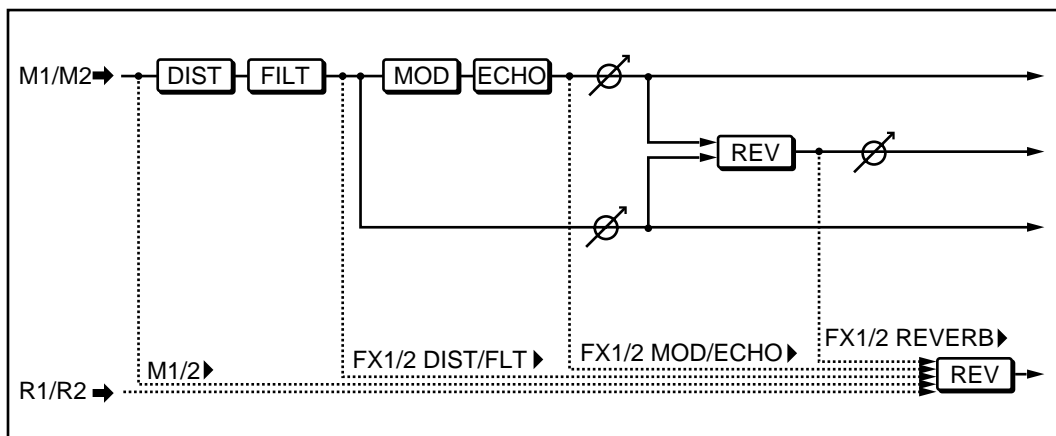

When REV►MOD/ECHO is selected

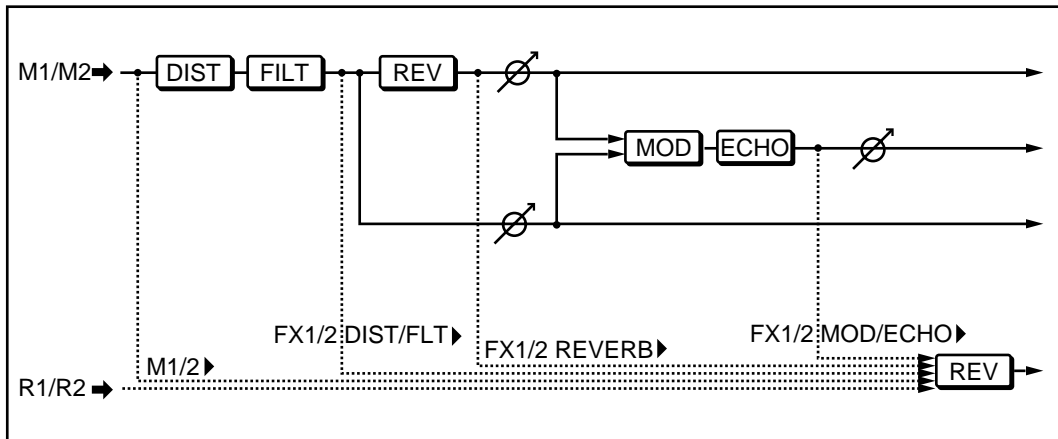

When MOD/ECHO+REV is selected

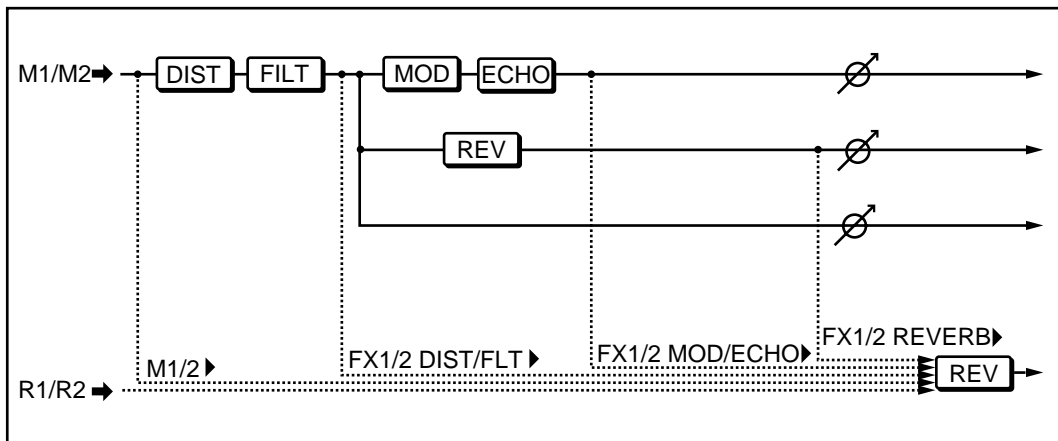

The output level and pan is set in the Effect Mixer window. Select the MIX module and press OPEN WINDOW

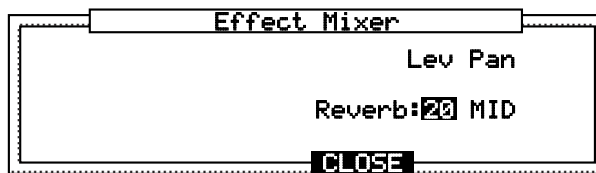

Editing Each Effect

Set the **Edit:** field to **MULTI FX1** (or **2**), select an effect (**DIST**, **FILT**, **MOD**, **ECHO**, **REV**) with the **CURSOR** keys and press **OPEN WINDOW**.

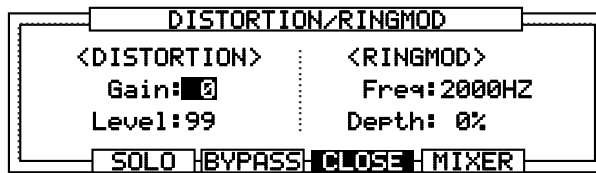

The function keys are the same for all effect windows.

By pressing **SOLO** [F2], you can listen to the effect currently open in this window and ignore all the other effects.

By pressing **BYPASS** [F3] you can bypass the current effect open in this window.

By pressing **MIXER** [F5], the Effect Mixer window will open.

Distortion/Ring Modulator

Distortion simulates the distorted sound produced by overloading an entry signal.

Ring modulator is an effect that changes the character of the sound by using the internal oscillator.

This produces a metallic sound with no scale.

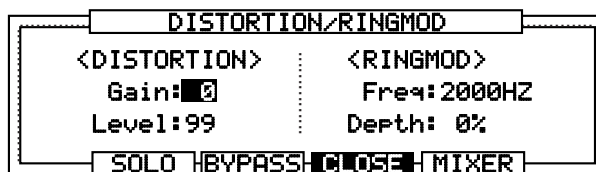

<DISTORTION>

Gain: This field adjusts the gain of the distortion. The distortion increases as the value increases.

Level: This adjusts the effect level.

<RINGMOD>

Freq: This sets the modulation frequency. A low value produces a tremolo effect and a high value produces a bell-like effect.

Depth: This adjusts the depth of the effect.

4 Band Filter

This four band filter consists of a high-pass filter, two middle pitch band pass filters, and a low pass filter. The frequency of each band is variable and can overlap each other. The scale of the middle pitch filter can be changed to produce an auto-wah effect.

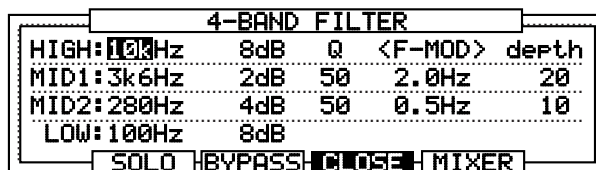

Set the center frequency and gain for each bandwidth.

The two middle-pitch Q's adjust the Q's of the filter. The larger the number, the wider the effect.

<F-MOD> adjusts the modulation frequency and **depth** adjusts the sweep amount.

Modulation

Modulation produces various effects such as phaser, flanger, chorus, rotary speaker, auto-pan, and pitch-shifter.

<Phaser>

Select PHASE SHIFT in the Type: field in Modulation window. The effect adds a hissing effect to the sound.

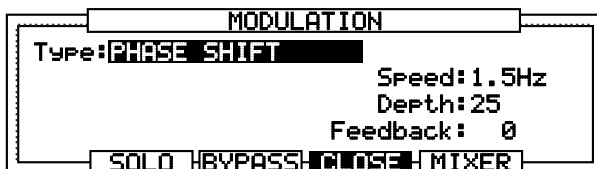

Speed: This adjusts the speed of the phase effect.

Depth: This adjusts the degree of the effect.

Feedback: This adjusts the signal volume that returns to the input from the effect output.

<Flanger>

Select FLANGE in the Type: field in the Modulation window. This effect also adds a hissing effect, but provides a deeper sound.



Speed: This adjusts the speed of the flange effect.

Depth: This adjusts the degree of the effect.

Feedback: This adjusts the signal volume that returns to the input from the effect output.

<Chorus>

Select CHORUS in the Type: field of the modulation window. This effect produces a sound effect similar to the playing of multiple instruments.



Speed: This adjusts the speed of the chorus effect.

Depth: This adjusts the degree of the effect.

Feedback: This adjusts the signal volume that returns to the input from the effect output.

<Rotary Speaker>

Select **ROTARY SPEAKERS** in the **Type#** field of the Modulation window. This effect simulates the sound of a rotary speaker.

**Speed1:**

This sets the rotating speed of the speaker.

Depth:

This adjusts the degree of the effect.

MIDI control#:

This sets the MIDI controller which changes the rotating speed. The controller can be randomly chosen from 128 types of MIDI controllers.

Acceleration:

This sets the time it takes to change the rotating speed of the speakers from Speed 1 to Speed 2 (or vice versa). This produces a real-life effect.

Speed2:

This sets the speed of the rotating speakers. You can switch between the value set in this field and in **Speed1:** with a MIDI controller.

Note: The switch between Speed 1 and Speed 2 borders at MIDI control level 64.

<Modulation and Auto-pan>

Select **FMOD/AUTOPAN** in the **Type#** field in Modulation window. This effect produces various effects such as vibratos and Doppler effects.

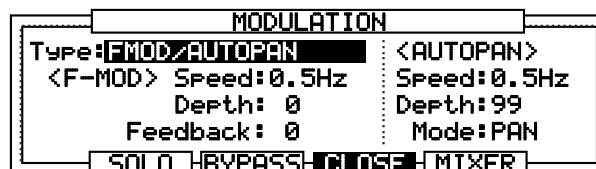
**<F-MOD>****Speed:**

This adjusts the anomalous frequency.

Depth:

This adjusts the width of the effect.

Mode:

This sets the type of effect.

- PAN** This simply swings the pan left and right.
- L>R** The level increases as the pan swings from left to right and decreases as it swings from right to left. This produces the effect of the sound rotating.
- R>L** This provides the opposite effect of the above.
- TREM** This does not pan the sound but produces a tremolo effect.

<Pitch Shifter>

Select **PITCH SHIFT** in the **Type#** field of Modulation window. This effect produces a shift in the pitch of the original sound.

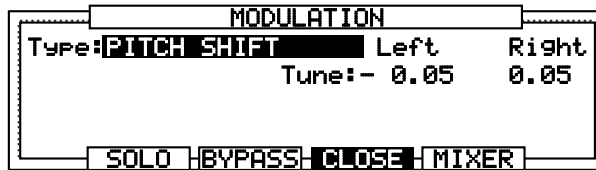

Tune# This sets the amount of the shift. The effect is processed in stereo and it is necessary to set both left and right.

<Pitch Shifter and Feedback>

Select **PITCH+FEEDBACK** in the **Type#** field of the Modulation window. This effect adds a delay effect to the pitch shift.

***Note:** When this is selected, it uses the delay circuit and ignores the DELAY/ECHO effect described later in this manual.*

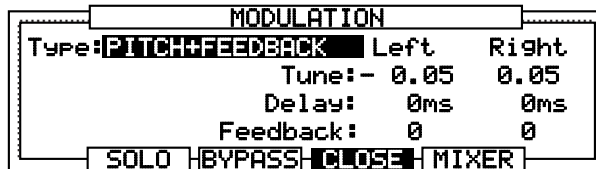

Tune# This sets the shift amount. The effect is processed in stereo and it is necessary to set both left and right.

Delay# This sets the delay time between 0 and 335 ms. The effect is processed in stereo and it is necessary to set both left and right.

Feedback# This sets the feedback volume. The effect is processed in stereo and it is necessary to set both left and right.

Delay/Echo

Delay/Echo is an effect which broadens the sound by overlaying sounds that are slightly delayed on top of the original sound. There are four modes to choose from.

<MONO LEFT>

Select **MONO LEFT** in the **Type:** field in DELAY/ECHO window. A monaural delay is added to the LEFT output of the stereo effect.

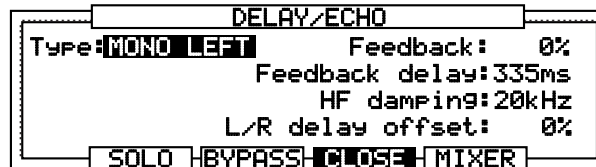

Feedback : This adjust the feedback volume.

Feedback delay: This adjusts the delay time between 0 ~ 670ms.

HF damping: This sets the frequency of the high frequency contained in the sound, within the feedback loop, that you want to remove.

L/R delay offset: By setting this to a number other than 0, you can create a panning delay effect. Set the ratio against time set in the **Feedback delay:** field. When the value is positive, the effect runs from right to left, when negative, the effect runs from left to right.

<MONO L+R>

Select **MONO L+R** in the **Type:** field in DELAY/ECHO window. This merges the outputs of the stereo effect and produces a monaural delay effect.

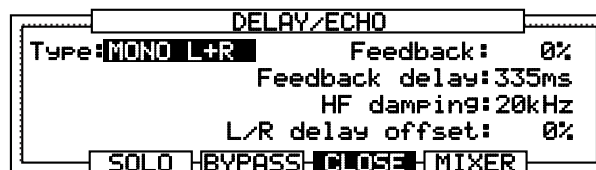

Feedback : This adjusts the feedback volume.

Feedback delay: This adjusts the delay time between 0 ~ 670ms.

HF damping: This sets the high frequency contained in the sound within the feedback.

L/R delay offset: When this is set to any number other than 0, it produces a panning delay effect. Set the ratio against time set in the **Feedback delay:** field. When the value is positive, the effect runs from right to left, when negative, the effect runs from left to right.

Note: When a monaural effect is selected, the sounds will merge even if a stereo MODULATION effect is selected. To maintain the stereo effect of MODULATION, select the following stereo type DELAY/ECHO effects.

<X-OVER L&R>

Select **X-OVER L&R** in the **Type#** field of Delay/Echo window. This returns the feedback of the stereo input signals after reversing the left and right channels. This produces an interesting pan delay effect.

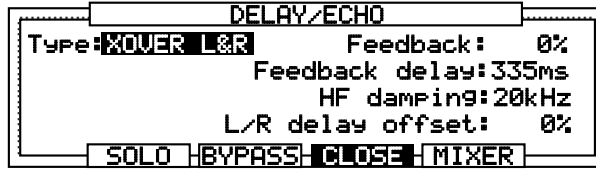

Feedback # This adjusts the feedback volume.

Feedback delay# This adjusts the delay time between 0 and 335ms.

HF damping# This sets the high frequency contained in the sound within the feedback.

L/R delay offset# When this is set to any number other than 0, it produces a panning delay effect. Set the ratio against time set in **Feedback delay#** field. When the value is positive, the effect runs from right to left, when negative, the effect runs from left to right.

<STEREO>

Select **STEREO** in the **Type#** field of Delay/Echo window. This produces a delay effect to both the LEFT and RIGHT inputs.



Feedback # This adjusts the feedback volume. The feedback volume of both left and right can be set individually.

Feedback Delay# This adjusts the delay time between 0 and 335ms. The delay time of both left and right can be set individually.

HF damping# This sets the high frequency contained in the sound within the feedback group. This can be set for left and right individually.

Reverb

The reverb effect adds an echo to the original sound. There are 3 main types: Hall (room) Gate, and Reverse.

<HALL, ROOM>

Select from `LARGE HALL`, `SMALL HALL`, `LARGE ROOM`, `SMALL ROOM` in the `Type:` field in the Reverb window. These create a feeling of space.

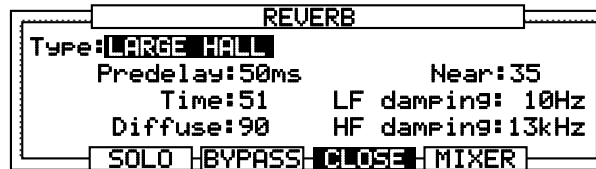

Predelay: This adjusts the delay time from the generation of the sound to the beginning of the reverb.

Time: This adjusts the time it takes for the reverb to diminish and dissolve.

Diffuse: This sets the density of the reflected sound of the reverb. When the value is low, the echo effect is emphasized. When it is high you get a smoother effect.

Near: This adjusts the distance from the sound source. The larger the value, the closer the sound, the smaller the value, the more distant the sound becomes.

LF damping: This cuts the low frequency contained in the reverb.

HF damping: This cuts the high frequency contained in the reverb.

<GATE>

Select `GATED 1` or `GATED 2` in the `Type:` field of the Reverb window. This produces an effect of a reverb sound that is forcedly cut. The decay characteristics differ between GATE 1 and GATE 2. GATE 2 sounds more synthetic.



Predelay: This adjusts the delay time from the generation of the sound to the start of the reverb.

Time: This adjusts the time it takes for the reverb to dissolve.

Diffuse: This sets the density of the reflected sound of the reverb. When the value is low, the echo effect is emphasized. When it is high you get a smoother effect.

<REVERSE>

Select REVERSE in the Type: field of Reverb window. The decay effect is reversed.

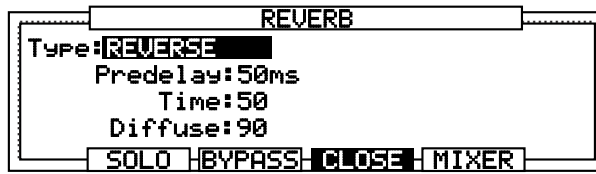

Predelay: This adjusts the delay time from the generation of the sound to the start of the reverb.

Time: This adjusts the time it takes for the reverb to dissolve.

Diffuse: This sets the density of the reflected sound of the reverb. When the value is low, the echo effect is emphasized. When it is high you get a smoother effect.

Copying an Effect

Four sets of effect settings (MULTI FX1,2, REVERB1,2) can be saved for each program. The settings of each set can be copied. The Copy Effect Settings Window will open by pressing OPEN WINDOW when the Edit: field is selected on the FXedit screen.

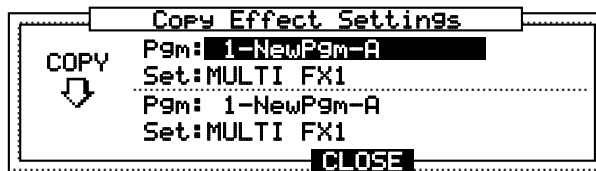

Top Pgm: This selects the name of the program you want to copy.

Top Set: This selects the effect set of the copy origin.

Bottom Pgm: This selects the name of the program you want to copy.

Bottom Set: This selects the effect set of the copy destination.

Note: The reverb settings can only be copied when MULTI FX is the copy origin and REVERB is selected as the copy destination or when the REVERB is the copy origin and MULTI FX is selected as the copy destination.

Press DO IT [F5] to copy.



Chapter 10

Disk Operation

Overview

When the power is turned off, all of the data will be erased. If you have any data that you want to keep, make sure that you save the data to a disk before the power is turned off.

The data will be saved as a file and you can name the file using up to 16 characters. There are two ways that you can save data on the MPC2000XL. One is by using the internal floppy disk drive, and the other is by connecting SCSI devices (such as MO, ZIP or hard disk drives) to the rear panel SCSI socket.

Disk mode screen

Hold down SHIFT and press LOAD (numeric pad 3). The following screen appears.

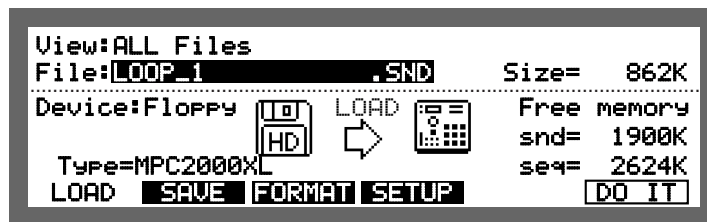

The Device: Field

In disk mode, most of the screens contain a `Device:` field. This selects which disk to work on when you operate various functions in disk mode and should be set first.

The Device Icons

When you select the disk in the `Device:` field in Disk mode, the following icons appear according to the type of disk selected.

Floppy



When Floppy is selected, the floppy icon appears. The display also indicates whether the disk is 2DD or 2HD.

Note: If the disk is not formatted, the MPC2000XL will not be able to make an indication.

SCSI

There are various types of SCSI devices. The MPC2000XL will display an icon according to the type of device connected to the MPC2000XL.

 **Hard disk**

 **CD-ROM drive**

 **MO drive**

This icon is also displayed:



MPC2000XL

Before Proceeding to Use a Floppy Disk

Do NOT press the disk eject button when you are using a floppy disk and the light of the disk drive on the front panel of the MPC2000XL is on. The data or disk may be damaged or destroyed.

SETTING UP the Primary Device

This sets up the primary device the MPC2000XL searches the file to load automatically when it is turned on. You can also select the type of file to be loaded.

- ① Hold down SHIFT and press LOAD (3 on the numeric keypad) followed by SETUP [F4]. The following SETUP screen will appear.



- ② Select the primary device in the Primary device: field. This selects the device that becomes active when the MPC2000XL is turned on. The available options are, FLOPPY, SCSI-0 ~ SCSI-7, and F-ROM.
- ③ Move the cursor to the Auto loading file type: field and select the type of file you want to load. This selects the type of file that is automatically loaded from the device selected above when the MPC2000XL is turned on. The available options are, APS+ALL, ALL, APS, and OFF (refer to the subsequent explanation of file types). The MPC2000XL will load the first APS and/or ALL file found automatically.

Formatting a Disk

In order to load or save a file to a floppy disk or an external SCSI drive, it is necessary to format the disk in order to use it with the MPC2000XL.

CAUTION: Once the disk is formatted, all the data on the disk will be erased.

Formatting a Floppy Disk

- ① Insert a floppy disk into the disk drive of the MPC2000XL, hold SHIFT and press LOAD (3 on the numeric keypad). Press FORMAT [F3] to display the format screen.
- ② By selecting FLOPPY in the Device: field, the following screen will appear.

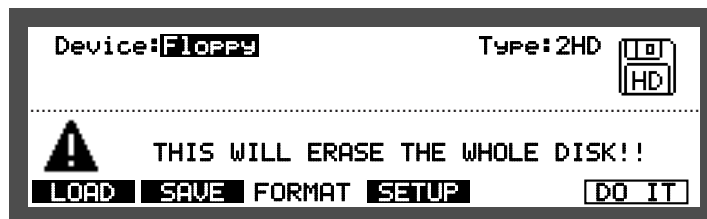

- ③ Select the type of disk in the Type: field. The MPC2000XL can use both 2DD and 2HD floppy disks, but cannot differentiate between the two if the disk is not formatted. Make sure the correct type is selected in the Type: field.
- ④ By pressing DO IT [F5], the following window appears.

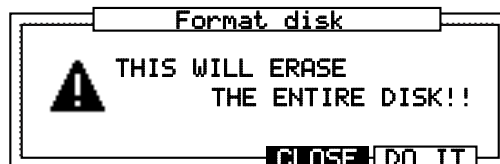

- ⑤ Pressing DO IT [F5] to format the disk.

When the disk is formatted, the following screen appears.

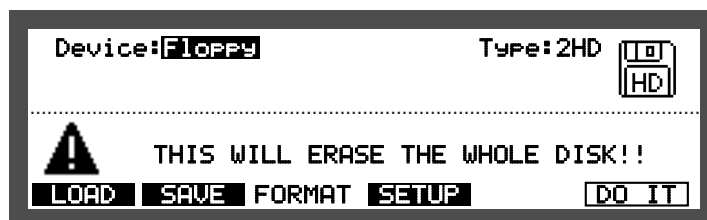

If you do not want to format any more disks, press MAIN SCREEN to return to the main screen.

Formatting a SCSI Drive

- ① Connect the MPC2000XL to an external SCSI drive using SCSI connectors (refer to “Connecting an External SCSI Drive”).
- ② Hold SHIFT and press LOAD (3 on the numeric keypad) to enter the Disk mode. Press FORMAT [F4] to display the format screen.
- ③ Select the SCSI ID number of the drive in the Device# field.

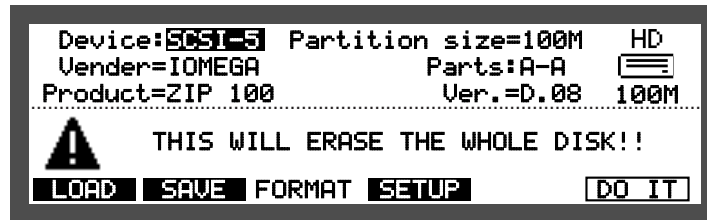

The Vendor=, Product=, Ver.= fields displays various information about the selected disk drive. The total disk capacity will appear under the icon on the far right.

- ④ Set the partitioning. When you are using a large disk, such as a hard disk, it is easier to manage files by dividing the disk into partitions which are then named in alphabetical order. The Partition size= field will display the size of each partition set in the Parts# field.
When A-A is selected in the Parts# field, the disk will not be partitioned. When A-D is selected in the Parts# field, the disk will be divided into four partitions: A, B, C, and D. The disk space will be equally divided.

Note: If a partitioned disk is connected to a PC, the partition data may be destroyed, preventing data retrieval.

- ⑤ Press DO IT [F5] to format.
If a disk such as a CD-ROM (which cannot be written to) is selected in the Device# field, Disk write error will appear, and the disk will not be formatted.

Note: The MPC2000XL is not compatible with the 1024K (or larger) sector sized MO disks.

Saving the Data

When the power is turned off, all of the data will be erased. If you have any data that you want to keep, make sure that you save the data to a disk before the power is turned off.

The MPC2000XL uses various files and they are labeled with different extensions depending on the type of file.

_____ .ALL	A file with 99 sequences and 20 songs.
_____ .MID	A standard MIDI, a sequence, file.
_____ .APS	All of the programs in the MPC2000XL memory when saved. The sounds in the memory will be saved as a separate sound file when the APS file is saved. The APS only contains program data, but when a file is loaded, the sounds used by the program will be loaded as well.
_____ .PGM	A program file. When a PGM file is saved, it will only contain program data, but when a file is loaded, the sounds used by the program will be loaded as well.
_____ .SND	MPC2000XL Sound file.
_____ .WAV	A sound file.

- ① Hold SHIFT and press LOAD (3 on the numeric keypad) to enter the Disk mode. Press SAVE [F2] to display the save screen.

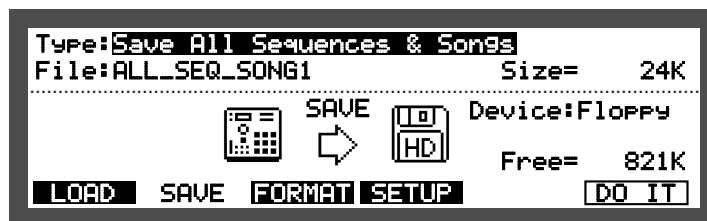

- ② Select the disk to which you will be saving the data in the Device: field. If you are saving to a floppy disk, select FLOPPY. If you are saving the data to an external SCSI drive, select the appropriate SCSI ID number.

Note: When SCSI is selected in the Device: field, the screen will display a Part: field and a folder icon will appear.

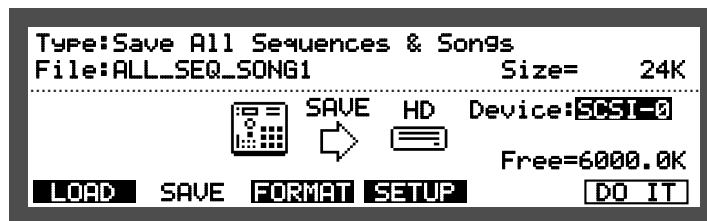

Select the partition you want to save to.

- ③ Select the type of data that you want to save in the Type: field. The operation will differ slightly depending on the selected type.

4-1. Saving All Sequences & Songs

This saves all the sequence and song data of the MPC2000XL's memory.

Select **Save All Sequence & Songs**. The file name will appear in the **File#** field.

Press **DO IT** [F6].

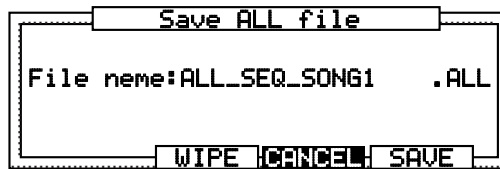

You can change the file name you are saving in the **File name#** field.

Tap a drum pad or rotate the **DATA** wheel to display the **Name** window.

After entering a name, press the **ENTER** [F5] key to confirm. If you save without pressing **ENTER** [F5] the entered name will be ignored and the file will be saved under the previous name.

4-2. Saving a Sequence

This saves a sequence data from the MPC2000XL's memory. The MPC2000XL sequence data will be saved as a standard MIDI file.

Select **Save a Sequence** and select the sequence you want to save in the **File#** field.

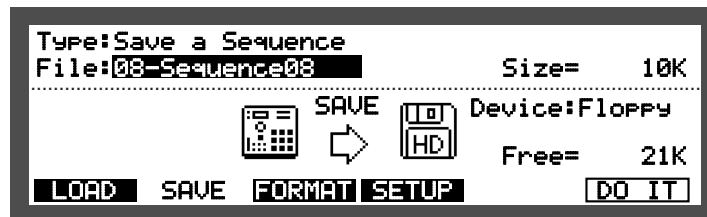

Press **DO IT** [F6].

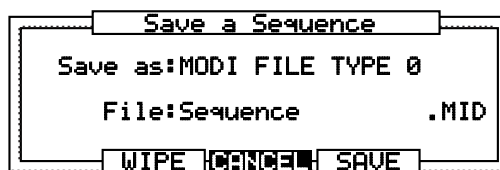

Select the type of standard MIDI file in the **Save as#** field.

MIDI FILE TYPE 0

The sequence data will be saved together on one track. The MPC2000XL proprietary track data, such as the track name, will be erased.

MIDI FILE TYPE 1

In contrast to **MIDI FILE TYPE 0**, data saved in this format will reproduce the conditions of the data. Normally select **TYPE 1**.

The selected file name will appear in the **File#** field.

4-3. Saving All Program & Sounds

This saves all the programs and sounds within the MPC2000XL memory. Select **Save All Program & Sounds**. The **File#** field will display the file name to be saved. Press **DO IT [F6]**.

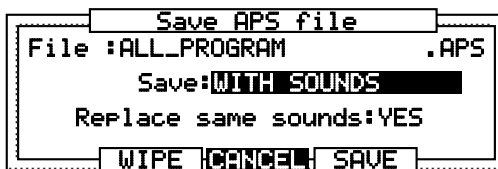

You can change the name of the file that you are saving in the **File name#** field.

Select whether or not to also save the sounds in the **Save#** field. When **WITH SOUNDS** or **WITH.WAV** is selected, the sound will also be saved.

When **WITH SOUNDS** is selected, the sounds are saved as MPC2000XL sound files (.SND). When **WITH.WAV** is selected, the sounds are saved as WAV (.WAV) files. The WAV file is compatible with computers but takes longer to load/save than a .SND file.

If **APS ONLY** is selected, only the program data will be saved (the sounds will not be saved).

If you select **YES** in the **Replace same sounds#** field, the new sounds will replace sounds with the same name already on the disk. If you select **NO**, they will not be replaced.

4-4. Saving a Program & Sounds

This saves one program from the MPC2000XL's memory. Select **Save a Program & Sounds**. Select the program that you want to save in the **File#** field. Press **DO IT [F6]**.

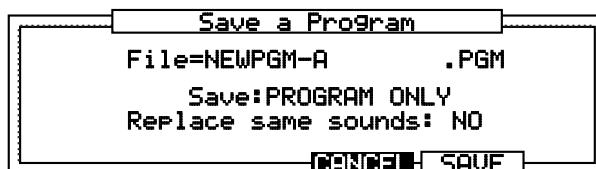

Select whether or not to also save the sounds in the **Save#** field. When **WITH SOUNDS** or **WITH.WAV** is selected, the sound will also be saved.

When **WITH SOUNDS** is selected, the sounds are saved as MPC2000XL sound files (.SND). When **WITH.WAV** is selected, the sounds are saved as WAV (.WAV) files. The WAV file is compatible with computers but takes longer to load/save than a .SND file.

If **PROGRAM ONLY** is selected, only the program data will be saved (the sounds will not be saved).

If you select **YES** in the **Replace same sounds#** field, the new sounds will replace sounds with the same name already on the disk. If you select **NO**, they will not be replaced.

The file name of the program being saved will appear in the **File#** field.

4-5. Saving a Sound

This saves each sound from the MPC2000XL's memory.

Select **Save a Sound**. Select the sound that you want to save in the **File#** field. Press **DO IT** [F6].

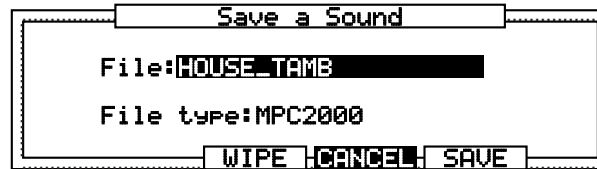

The file name of the sound being saved will appear in the **File#** field.

5-1. Press **WIPE** [F3] to display the following window (this only appears when a floppy disk is being used).

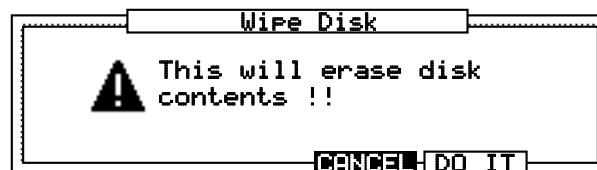

Press **DO IT** [F5] to erase all the data on the disk and save.

5-2. Press **SAVE** [F5] to execute save.

If you do not want to save any more files, press the **MAIN SCREEN** key to return to the main screen.

Saving Across Multiple Floppy Disks

In cases such as **Save All Program & Sounds**, where a large quantity of data is being saved on a floppy disk, one disk may not be enough. In this case, the following window will appear when there is not enough space left on the disk after the first disk becomes full.



Insert a new floppy disk here. You can erase all the data on the newly inserted disk, press **WIPE** [F3]. The **Wipe Disk** window will appear, and by pressing **DO IT** [F5] the contents of the disk will be erased and the rest of the data will be saved. If you do not want to erase the contents of the newly inserted disk, press **SAVE** [F5] on the "Disk is full!!" window to save the data to the remaining disk space.

When the "Disk is full!!" window is displayed, the **Change disk to continue!!** message will appear if you do not change the disk and press **WIPE** [F3] or **SAVE** [F5]. In this case, insert a new disk and press **WIPE** [F3] or **SAVE** [F5].

Note: If you are saving data to a SCSI drive, the disk must be MPC2000XL formatted in order to save data from the MPC2000XL. You also cannot execute save if the disk selected in the **Device#** field is a disk that cannot be written to such as the CD-ROM.

Saving to Folders on a SCSI Device

Creating a New Folder

If you have a SCSI disk device connected to the MPC2000XL, you can make separate folders that you can save files to, the same as you would on a computer.

For example, you could have separate folders for drum sounds, piano sounds, loops, etc. You can also place folders within folders.

- ① Hold down SHIFT and press LOAD (numeric key 3).

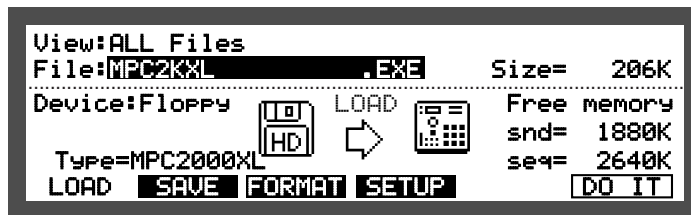

- ② Move to the **Device:** field with the CURSOR keys and select the SCSI ID number that you have set your external disk to with the DATA wheel (if there is no device set to the selected SCSI ID number “No SCSI device!” will appear).

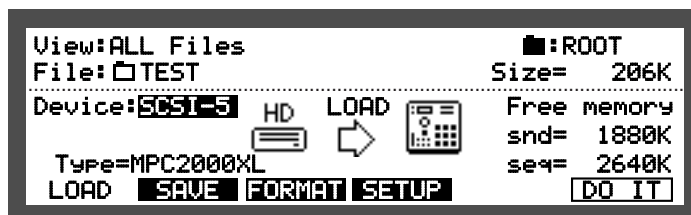

- ③ Move to the folder field (📁) in the top right of the screen and press OPEN WINDOW to open the Directory window. (You can also press OPEN WINDOW when the cursor is in the **File:** field of the LOAD screen.)

There will be a “ROOT” file already named. The list on the left hand side shows only the first 8 letters of the folder's name.

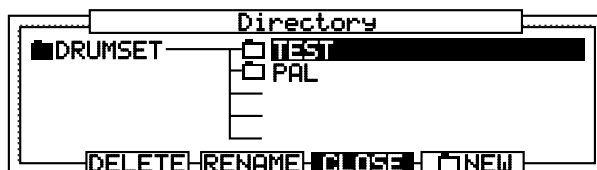

- ④ Press **NEW** [F5].
Tap a drum pad or rotate the DATA wheel to display the name window.
Press **ENTER** [F5] to save the new name and create the folder.
- ⑤ Press **CLOSE** [F4] to return to the “LOAD” screen (you can continue making other folders before pressing “Close”).
The last selected folder will appear in the **File:** field and you can now save into this folder.

Making Folders Within Folders

- ① To make a new folder inside an existing folder, follow steps 1 - 3 of “Creating a New Folder”.

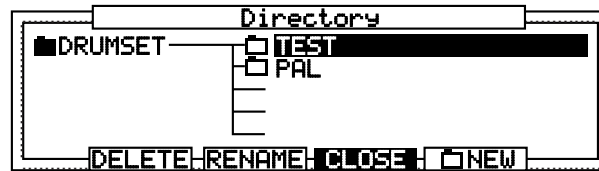

- ② Select one of the existing folders with the CURSOR UP/DOWN keys.

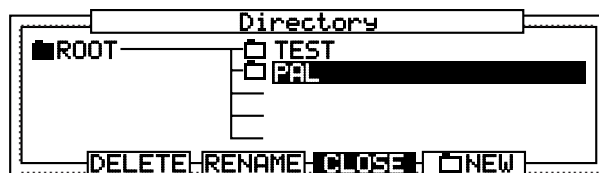

- ③ Press the CURSOR RIGHT key to open the folder (press the CURSOR LEFT key to move back through folders). The list on the right hand side shows both folders and files.

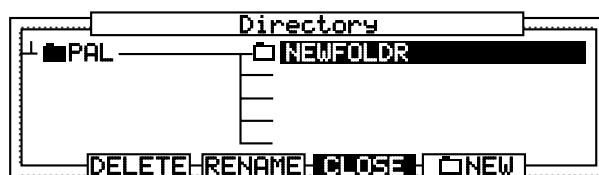

- ④ Follow steps 4 - 5 of “Creating a New Folder”.

Selecting Folders/Files

Once you have created folders and files, you will need to be able to navigate through them so that you can load or save files.

- 1 Follow steps 1 - 3 of “Creating a New Folder”.

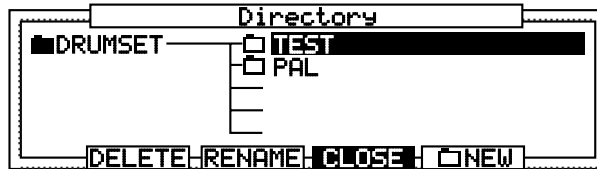

- 2 Use the CURSOR keys to select a file or folder.
UP/DOWN keys: to move up or down a list of files/folders.
RIGHT key: to open folders.
LEFT key: to move back to the previous folder.

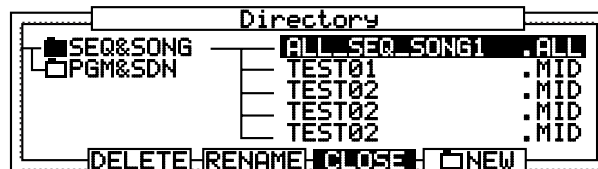

- 3 Press **Close** [F4] to return to the “LOAD” screen.
 The last selected folder/file will appear in the **File:** field and you can now save into this folder or load the selected file/folder.

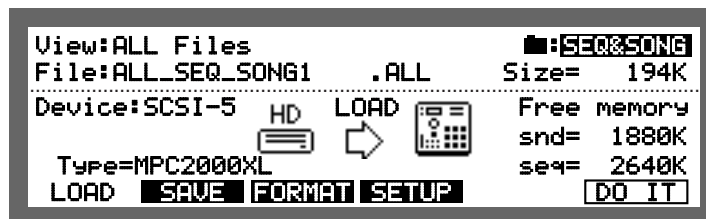

Note:

Once a folder is selected and it appears in the top right of the LOAD screen, you can select files from the folder by moving to the **File:** field and scrolling through the contents of the folder with the DATA wheel.

Deleting Folders

- ① Follow steps 1 - 2 of “**Selecting Folders/Files**”.
- ② Press **DELETE** [F2]. The Delete Folder window appears.



- ③ Press **DO IT** [F5].
The folder and its contents will be deleted.

Renaming Folders

- ① Follow steps 1 - 2 of “**Selecting Folders/Files**” and select the folder to be renamed.
- ② Press **RENAME** [F3]. The name window appears.
Enter the new name and press **ENTER** [F5] to save the new name.
- ③ Press **Close** [F4] to return to the Disk Mode screen.

Loading Files

The following files can be loaded into the MPC2000XL:

- _____ **.SND** Sound file.
- _____ **.SEQ** Sequence file.
- _____ **.ALL** All sequence and song files.
- _____ **.MIDI** Standard MIDI file.
- _____ **.PGM** Program file.
- _____ **.APS** Multiple programs.
- _____ **.WAV** PC wave file.
- _____ **.SET** Set of sounds

- ① Hold SHIFT and press LOAD (3 on the numeric keypad) to display the LOAD screen.

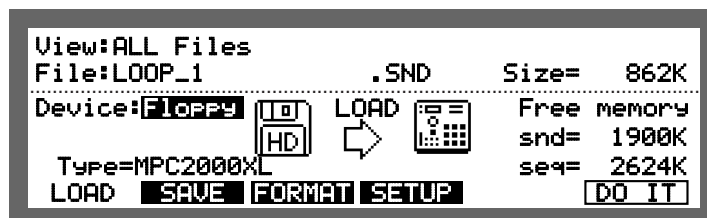

- ② Select the disk that you want to load from in the **Device:** field. If you are loading from a floppy disk, select **FLOPPY**. If you are loading data from an external SCSI drive, select the appropriate SCSI ID.
If loading from a file/folder on an external SCSI disk device, see “**Selecting Folders/Files**”.

- **Type:**
Displays the data of the drive selected in **Device:**.
 - MPC2000XL An MPC2000XL disk.
 - MPC2000 An MPC2000 disk.
 - MPC3000 An MPC3000/MPC60 disk.
 - S3000 An S3000 disk.
 - S1000 An S1000 disk
 - PC An MS-DOS formatted disk.
 - ???? An unformatted disk or an incompatible format disk.
- **Size:**
Displays the data size of the file selected in the **File:** field.
- **Free memory snd=**
The free sound memory space on the MPC2000XL.
- **Free memory seq=**
The free sequence memory space on the MPC2000XL.

Note: When SCSI is selected in the Device: field, the Part: field appears on the screen.

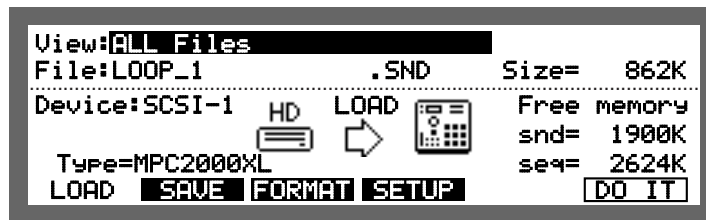

Select the partition that you want to load from.

If you are using a disk with a large amount of disk space, such as a hard disk, it is easier to manage the files by dividing the disk space into partitions (see "Formatting a SCSI Drive").

If you are loading CD-ROM data used with the S1000 or S3000, the Vol: field will appear to the right of the View: field.

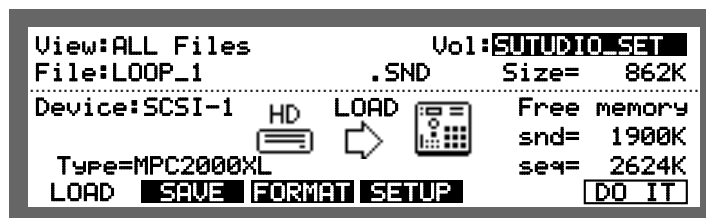

S1000 or S3000 disks are divided into partitions and then to smaller units called volume. When you are selecting a file to load, select a partition in the Part: field, a volume in the Vol: field, and the sound in the File: field.

You can select the file type you want to display in the File: field of View: field. It is possible to select a specific extension in the View: field. This enables you to display only the files with the extension selected in the View: field in the File: field. This is convenient to find a file when there are many files on a disk.

- ③ Select the file you want to load in the File: field. The procedures differ slightly depending on the type of file selected.

4-1. Selecting .SND (sound) Files or .WAV (wave) Files

Press DO IT [F6] to load a sound file. The following window appears when loading is completed.

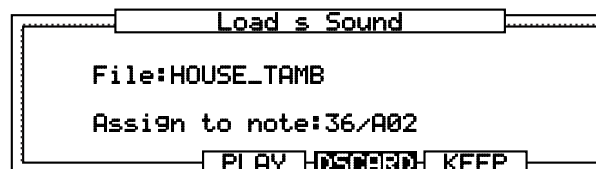

The file name will appear in the File: field.

Press PLAY [F3] to listen to the sound.

Select the note number or drum pad that you want to assign the sound to in the Assign to note: field. You can rotate the DATA wheel or select directly by playing the pad. Select --/OFF by rotating the DATA wheel if you don't want to assign the sound to a note number.

If you don't want to keep the loaded sound, press **DSCARD** [F4] to discard it.

Press **KEEP** [F5] to load the sound to the selected drum pad.

4-2. Loading .SEQ (sequence) or .MID (standard MIDI) Files

Press **DO IT** [F6] to load the sequence file. The following window appears when loading is completed.

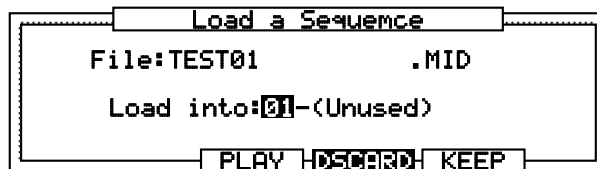

The file name will appear in the **File#** field.

Press **PLAY** [F3] to listen to the sequence.

Select the sequence number that you want to assign the sequence data to in the **Load into#** field.

Press **KEEP** [F5] to assign the loaded file to the sequence number.

Note: The MPC2000XL can load sequence files of up 50,000 note events (approximate file size of 250kb) per sequence. If you try to load a file larger than this, only the first 50,000 note events will be loaded.

If you do not want to keep the file, press **DSCARD** [F4] to discard it.

4-3. Loading .PGM (program) Files

When a program file is loaded, the selected program and the sounds assigned to that program will be loaded.

Press **DO IT** [F6] to display the following window.

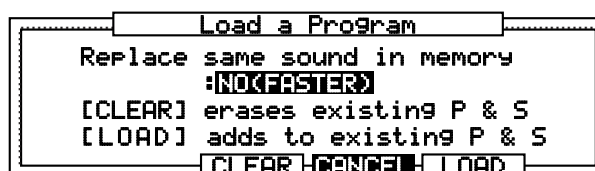

The **Replace same sound in memory#** field selects whether to replace the same sound in the MPC2000XL's memory with the sound on the disk (if the sound assigned to the loaded program already exists). If this is set to **YES**, all of the data on the disk with the same name will replace the sounds in the MPC2000XL's memory. If this is set to **NO**, sounds with the same name will not be loaded and the sounds in the MPC2000XL's memory will be used.

Press **CLEAR** [F3] to erase all the program and sound data within the memory and load the new program.

Press **LOAD** [F5] to add to existing programs and sounds.

CAUTION: The following window will appear when you are loading a program and a sound file assigned to that program cannot be found.

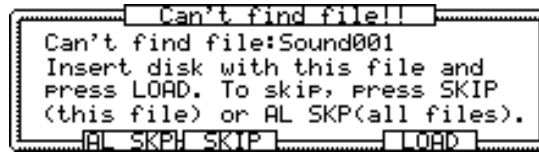

Insert the disk with the sound displayed in the Can't find file: field and press LOAD [F5]. If you have saved across multiple floppy disks, insert the next disk and press LOAD [F5].

If you press SKIP [F3], the sound that cannot be found will be skipped and the next sound file will be loaded. If another sound file is not found, the above window will appear again.

Press AL SKP [F2] to cancel the loading of further sound files.

4-4. .ALL Files

Press DO IT [F6] to display the following window.

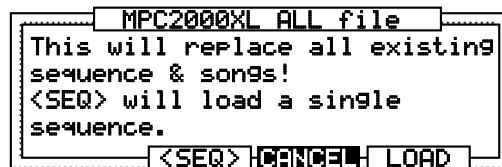

Press LOAD [F5] to load all sequence and song files. Be careful, since all of the sequence and song file data within the memory will be erased.

Press <SEQ> [F3] to select and load each sequence in the .ALL file.

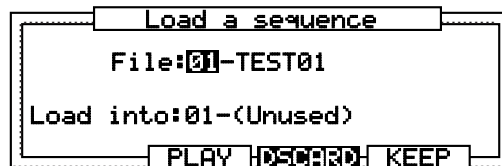

The procedure here is the same as "Loading .SEQ (sequence) or .MID (standard MIDI) Files."

Note: The MPC2000XL can load sequence files of up 50,000 note events (approximate file size of 250kb) per sequence. If you try to load a file larger than this, only the first 50,000 note events will be loaded.

4-5. .APS (all programs) File

Programs and the sounds assigned to the programs will be loaded when you load an .APS file.

Press DO IT [F6] to display the following window.

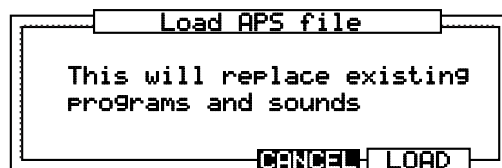

Press LOAD [F5] to load the program and sound files. Be careful, since all of the program and sound data within the memory will be erased.

When you have finished, press MAIN SCREEN to go to the main screen and play the sounds.

Deleting a File from the Disk

You can select and delete files from the disk.

1. Hold SHIFT and press LOAD (3 on the numeric keypad).

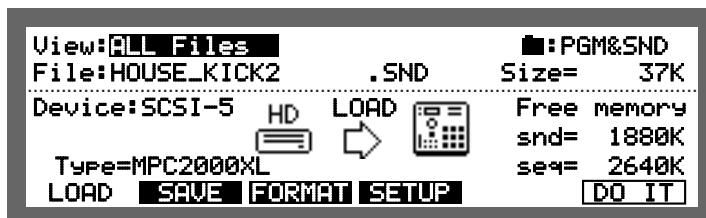

2. Move the cursor to the Device: field and select the device that contains the file that you want to delete.

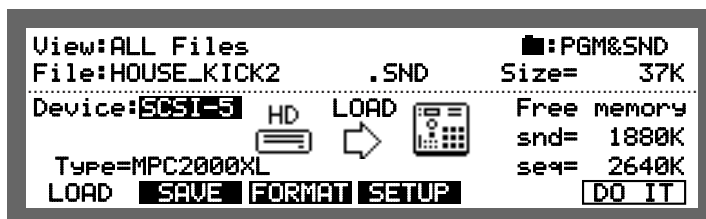

Note: You can select the file type that you want to display in the File: field of the View: field. It is possible to select a specific extension in the View: field. This displays only files with the selected extension, which is convenient for finding a file when there are many files on a disk.

3. Move the cursor to the File: field and press OPEN WINDOW to display the Directory window.

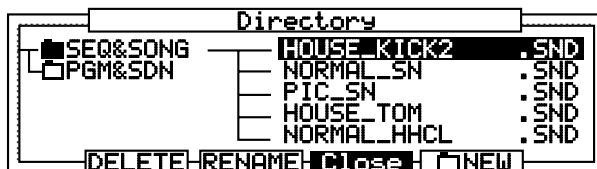

4. Select the file that you want to delete with the CURSOR keys (see the “Selecting Folders/ Files” section) and press DELETE [F2].



5. Press DO IT [F5] to delete the selected file. If ALL [F3] is pressed, the Delete ALL files window will appear and all the files on the same layer/level as the selected file can be deleted. Select the file type in the Delete: field.

The file type options are as follows:

ALL FILES	Deletes all files
.SND	Deletes only the MPC2000XL sound files
.PGM	Deletes program files
.APS	Deletes files that contain All Program and Sound data
.MID	Deletes standard MIDI files
.ALL	Deletes set of sequence and song files
.WAV	Deletes WAV type sound files
.SEQ	Deletes sequence files
.SET	Deletes sound set files

Pressing **DO IT** [F5] deletes all the files of the specified type.

Loading an Updated Operating System

From time to time, updated operating systems will become available on floppy disks or can be downloaded from our internet web site.

To update your operating system, insert the floppy disk (or connect the SCSI device which contains the files of the operating system) and hold down **SHIFT** and press **LOAD** (numeric key 3).

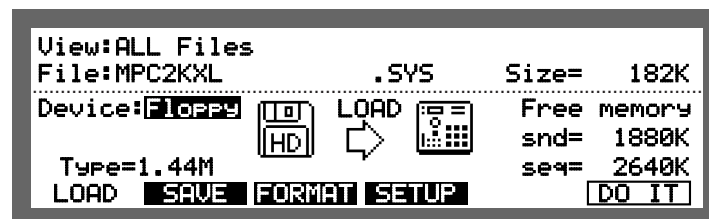

Select either the MPC2KXL.EXE or MPC2KXL.SYS file in the **File:** field and press **DO IT** [F6].

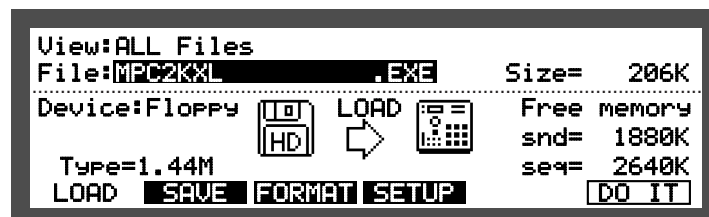

Press **DO IT** [F6] again, the system will be automatically updated and a display will appear to prompt you to restart the MPC2000XL.

Loading Files Created on the AKAI MPC60/60II

Loading a Sound (.SND) file

Follow steps 1 to 4-1 in "Loading Files" and select the .SND file in step 3.

Loading Sound Set (.SET) Files

Follow steps 1-3 in "Loading Files" and select the .SET file in step 3. Then press DO IT [F6].

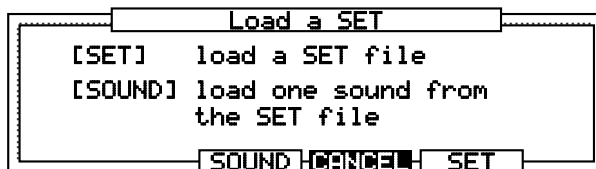

Press SET [F5].

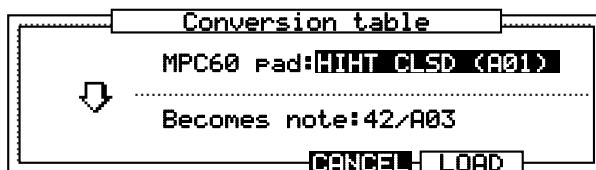

The sounds assigned to the MPC60/60II can now be converted to Note Numbers on the MPC2000XL.

Select one of the pads of the MPC60/60II in the MPC60 Pad: field, and then select the Note Number that you want to assign it to in the Becomes note: field, then press LOAD [F5].

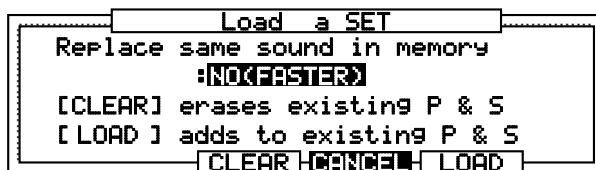

Then continue from step 4.

Loading a Sound from a Set File

This way, you can load a specific sound from a set file.

Follow steps 1-3 in "Loading Files" and select the .SET file in step 3. Then press DO IT [F6].

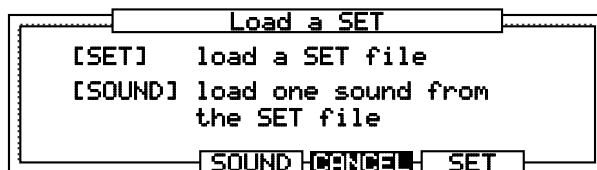

Press SOUND [F3].

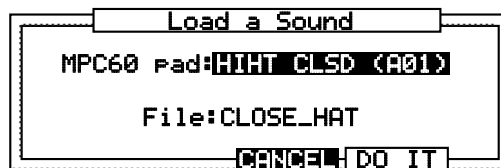

Select one of the pads of the MPC60/60II in the MPC60 Pad: field, or select the name of the sound at the File: field, then press DO IT [F5].

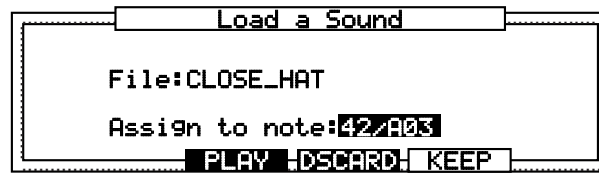

The loaded sound can be played by pressing **PLAY** [F3].
 Set the Note Number to be assigned in the **Assign to note:** field.
 To save the sound, press **KEEP** [F5]. To delete the sound to free the memory, press **DISCARD** [F4].

Loading a Sequence (.SEQ) File

Follow steps 1-3 in "Loading Files" and select the .SEQ file in step 3. Then press **DO IT** [F6].

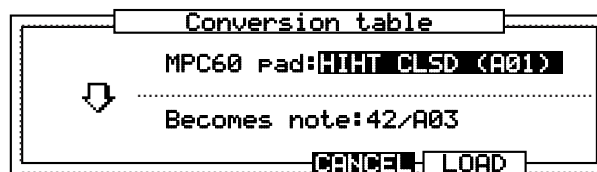

The pad number recorded in the Sequence data of the MPC60/60II can now be converted to Note Numbers on the MPC2000XL.

Select one of the pads of the MPC60/60II in the **MPC60 Pad:** field, and then select the Note Number that you want to assign it to in the **Becomes note:** field, then press **LOAD** [F5].

Note:

When the sequence and sound files of the MPC60/60II are loaded and used at the same time, it is necessary to match the settings of the conversion table to those of the sound set file.

Press **DO IT** [F6].

Loading an All (.ALL) File

Follow steps 1-3 in "Loading Files" and select the .ALL file in step 3. Then press **DO IT** [F6].

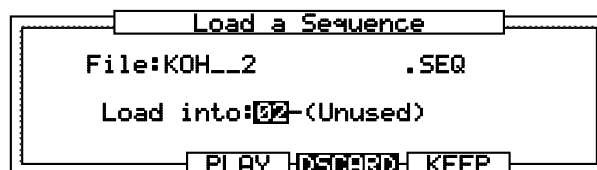

Then continue from step 4.



Chapter 11

Flash ROM (optional)

Flash ROM

By installing the optional flash ROM board FMX008M (which has 8MB of memory), you can save data to the flash ROM. Saving data to the flash ROM saves RAM space.

When you are installing the flash ROM board, please refer to the manual supplied with it.

Formatting the Flash ROM

Before using the flash ROM, you must format it first. Enter Disk mode by holding down SHIFT and pressing LOAD (3 on the numeric pad). Select F-ROM in the Device: field and press FORMAT [F3] to display the format screen.

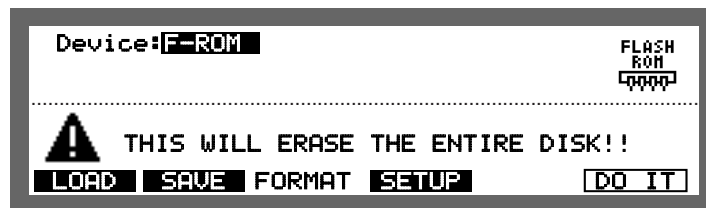

Press DO IT [F6].

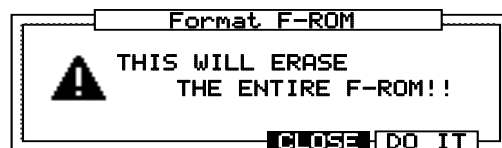

The above message appears, and the format begins when you press DO IT [F5].

Note: Once formatting is carried out, all of the data on the flash ROM will be erased.

Saving to Flash ROM

You can save data into flash ROM in the same way you would a floppy disk or SCSI device. Hold down SHIFT and press LOAD (numeric key 3) and then press SAVE [F2].

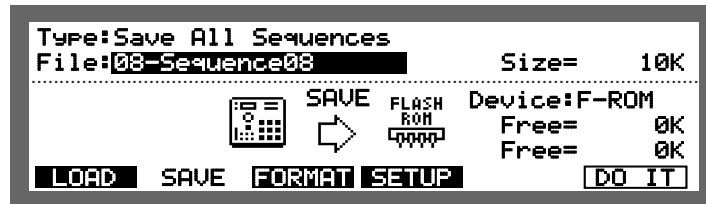

File: This field selects the file that you want to save.

Device: Select F-ROM.

Frag'd= This field shows the hollow memory size of fragmented data. Please refer to Flash ROM Fragmentation described later in the manual.

Press DO IT [F6].

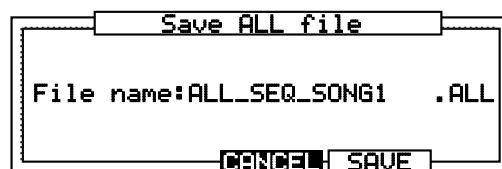

Press SAVE [F5] to save the file.

Loading from Flash ROM

You can load data from flash ROM in the same way you would load from an ordinary disk. Hold down SHIFT and press LOAD (numeric key 3) and then press LOAD [F1].

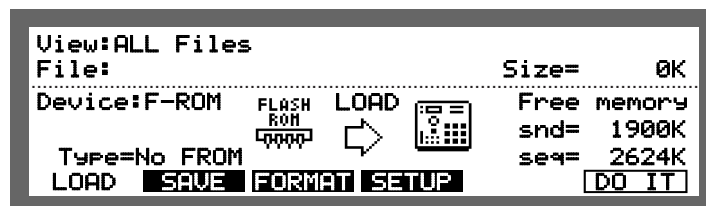

Move the cursor to the Device: field and select F-ROM. Move the cursor to the top right folder field and press OPEN WINDOW to open the Directory window. You can also open the Directory window by pressing OPEN WINDOW while the cursor is in the File: field.

Select a file with the CURSOR keys. Press Close [F4] to return to the LOAD screen and then press DO IT [F6] to load the data.

Note: You cannot load a sound from flash ROM if you have a sound of the same name in the MPC2000XL's RAM. (internal memory).

Deleting Data from Flash ROM

You can delete a file from the flash ROM in the same way you would from an ordinary disk. Move the cursor to the **Device:** field and select **F-ROM**. Move the cursor to the top right folder field and press **OPEN WINDOW** to open the Directory window.

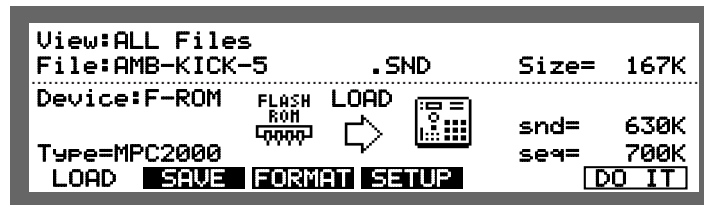

Press **DELETE** [F2] and select the file that you want to delete with the **CURSOR** keys.

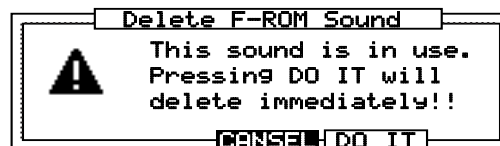

Press **DO IT** [F5] to delete the file.

Flash ROM Fragmentation

When the MPC2000XL writes data to the flash ROM, it writes consecutively in the available area. However, when flash ROM data is deleted, empty spaces develop between the data unless the data is written in the last available space. Wave pattern data which is saved to the flash ROM is directly generated, and always needs to be one link of data. In this case, the MPC2000XL will not write to an area if the area is too small for the wave pattern data and will write in another available space. Therefore, there may be cases when wave pattern data cannot be saved to the flash ROM even if the total available space is larger than the data size of the wave pattern. This type of available disk space sandwiched between data appears on the **Frag'd** field of the **Save** screen. The MPC2000XL can organize data allocation and increase the available consecutive disk space. Select **F-ROM** in the **Device:** field of each Disk mode screen and press **OPEN WINDOW**.

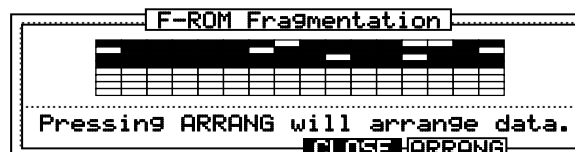

The window will display the data fragmentation. The colored area is where data exists. Press **ARRANG** [F5] to de-fragment the data.

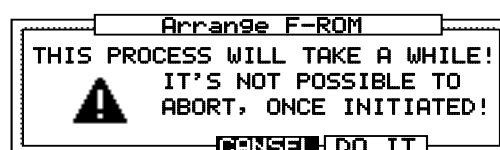

Press **DO IT** [F5] to continue.

Note: Do not turn the MPC2000XL off during de-fragmentation. The data in the flash ROM will be destroyed and cannot be recovered.

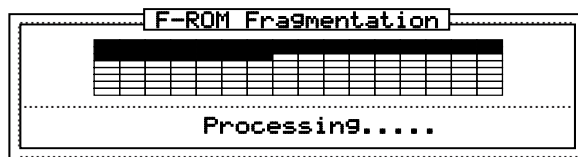

The above window appears during de-fragmentation.

Note: It will take several minutes to complete the operation.

Editing a Sound within the Flash ROM

When sound data stored in the flash ROM is loaded, only the location information of the data is loaded to the RAM, wave pattern data is not loaded. Therefore, you can handle more data on the RAM. However, to edit wave pattern data within the flash ROM, it is necessary to load it temporarily into the RAM.

In the same way as you would normally load sounds, load the sound from Flash ROM by holding down SHIFT and pressing LOAD (or 3 on the numeric pad).

At this point, the wave data has not yet been transferred to the MPC2000XL's RAM . Load the same sound again, the wave data will be transferred to the RAM.

You can perform all the normal editing operations after the wave data has been transferred to the RAM.

When you have finished editing, save the data back to the flash ROM.

If you enter the same name as the original data, you can overwrite the original.



Chapter 12

MIDI/SYNC Mode

OTHER Mode

MIDI/SYNC Mode

The MPC2000XL complies to MIDI CLOCK, MIDI TIME CODE and MIDI MACHINE CONTROL messages. This enables you to synchronize with other sequencers and also by using a MIDI MACHINE CONTROL compliant MTR (Multi Track Recorder) control the MTR from the MPC2000XL.

If you are only using the MPC2000XL or connecting it to a MIDI sound source and not using another sequencer or MTR, it is not necessary to set MIDI/SYNC mode.

Synchronizing the MPC2000XL with Other Sequencers

To set the other sequencer as the master and synchronize the MPC2000XL to it, connect the MIDI OUT of the sequencer to the MIDI IN of the MPC2000XL.

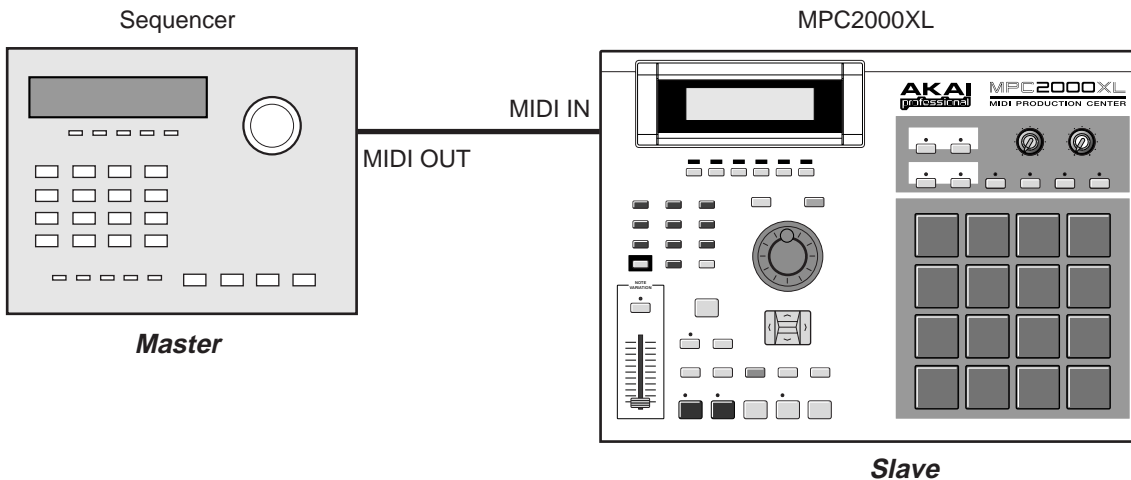

Hold down SHIFT and press MIDI/SYNC (9 on the numeric pad) to display the MIDI/SYNC mode screen.

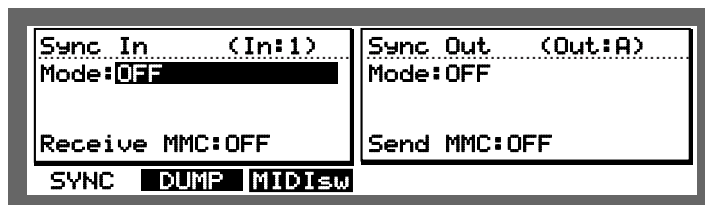

To set the MPC2000XL as the slave device and receive MIDI synchronous signals, set the Sync In window on the left.

In the In# field, select the MIDI Input from which you will be receiving sync-in data. In the Mode# field, select the type of synchronous signal you will be using: MIDI CLOCK or MIDI TIME CODE.

◆ MIDI CLOCK

MIDI CLOCK is a general synchronization signal which most sequencers are equipped with. When MIDI CLOCK is used, the tempo is determined by the settings of the master sequencer.

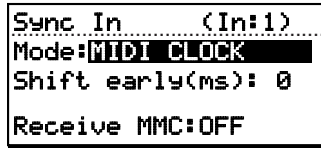

Shift early(ms):

When you are playing synchronously, set the offset which slides the timing against the master. Normally, leave this set to 0.

◆ MIDI TIME CODE (MTC)

In contrast to MIDI CLOCK, MIDI TIME CODE is a synchronous signal with absolute time. The MTC does not have tempo data and therefore it is necessary to set the tempo change on the master device and the MPC2000XL.

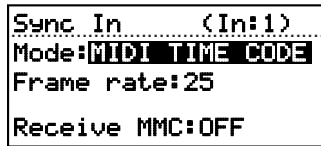

Frame rate:

Set this to the same frame rate being used by the master device.

You can set the start time of the sequence or song when synchronizing with MTC. Move the cursor to the Now: field in the Main or Song Screen and press OPEN WINDOW to display the following window.



Start time: The playback starts when the time code set here is received.
 Frame rate: Sets the frame rate of the time code.

◆ OFF

The MIDI synchronous signal is ignored when Mode: is set to OFF.

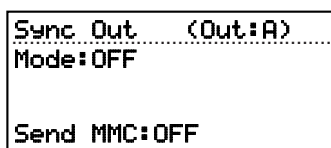

Receive MMC:

This allows you to receive MIDI Machine Control messages.

Synchronizing Another Sequencer or MTR to the MPC2000XL

To set the MPC2000XL as a master and synchronize another sequencer to it, connect the MIDI IN of the sequencer to the MIDI OUT of the MPC2000XL.

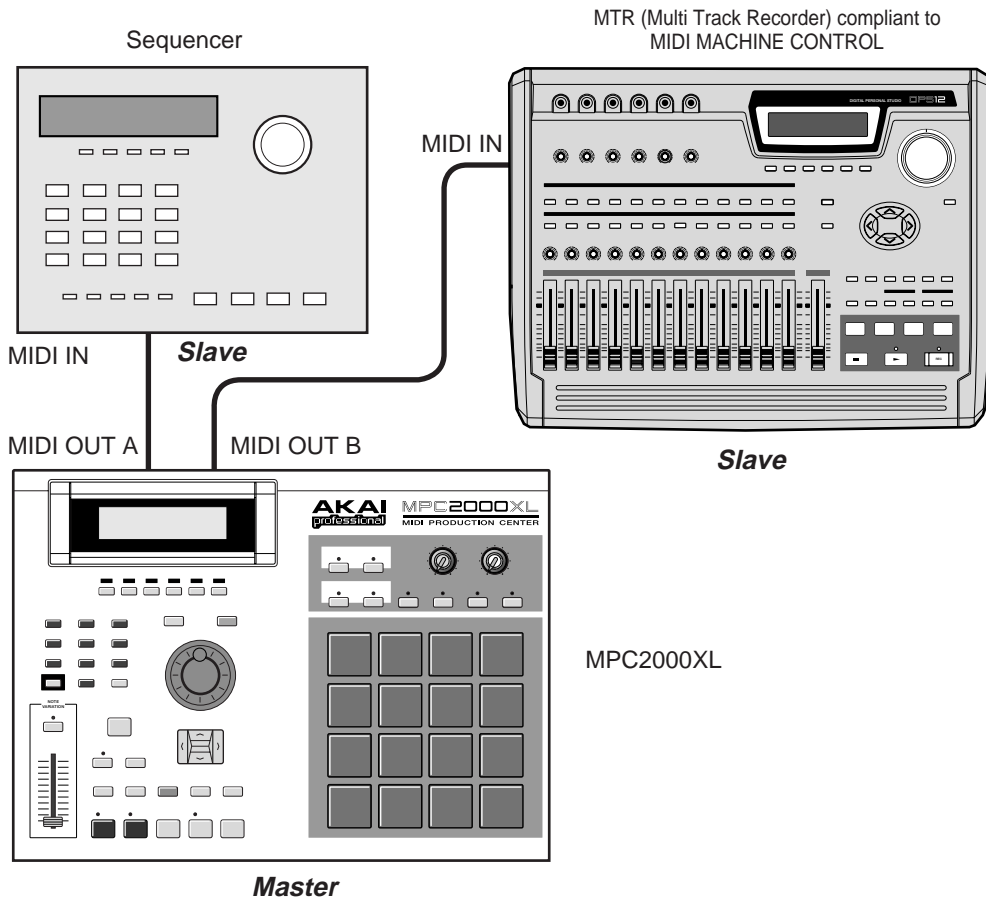

CAUTION: It is necessary to use an MTR (Multi Track Recorder) compliant with MIDI MACHINE CONTROL (MMC) in order to synchronize it with the MPC2000XL using MMC.

Hold down SHIFT and press MIDI/SYNC (9 on the numeric pad) to display the MIDI/SYNC mode screen.

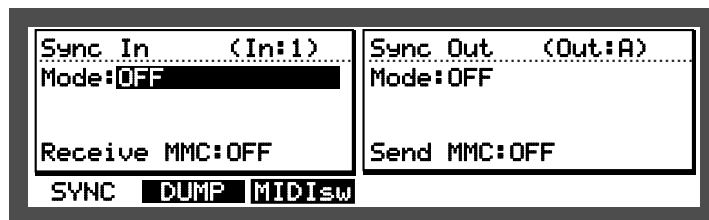

To set the MPC2000XL as the master and send synchronous signals to other MIDI equipment, set the **Sync Out** window on the right.

First, in the **Out:#** field, select the MIDI Output to which you will output the synchronization data. Both of the MIDI OUT A/B terminals of the MPC2000XL can be used at the same time. In the **Mode:#** field, select the type of synchronous signal you will be using: MIDI CLOCK or MIDI TIME CODE.

◆ MIDI CLOCK

MIDI CLOCK is a general synchronization signal which most sequencers are equipped with. When MIDI CLOCK is used, the tempo of the MPC2000XL will control another sequencer.

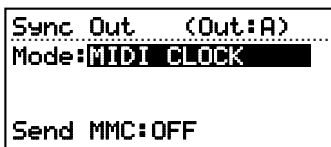

◆ MIDI TIME CODE (MTC)

In contrast to MIDI CLOCK, MIDI TIME CODE is a synchronous signal with absolute time. The MTC does not have tempo data and therefore it is necessary to set the tempo change on the slave device and the MPC2000XL.

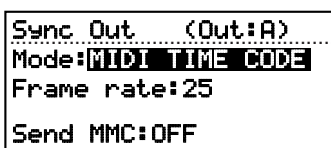

Frame rate:

Set this to the same frame rate being used by the slave device.

You can also set the start time of the sequence or song when synchronizing with the MTC. Move the cursor to the Now: field in the Main or Song Screen and press OPEN WINDOW to display the following window.



Start time: The playback starts when the time code set here is received.
 Frame rate: Sets the frame rate of the time code.

Send MMC:

This allows you to send MIDI Machine Control messages.

◆ OFF

The MIDI synchronous signal is ignored when Mode: is set to OFF.

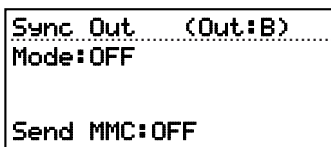

Synchronizing with the SMPTE Time Code

By installing the optional SMPTE IC chip IC-M2TC, you can synchronize using SMPTE. SMPTE is a time code signal containing absolute time information.

Connecting

To receive time code from an external device, connect the SMPTE OUT jack of the other device to the SMPTE IN jack on the rear panel. To output time code to an external device, connect the SMPTE IN jack of the other device to the SMPTE OUT jack on the rear panel.

Setting Directions

SMPTE synchronizing is set in the same way as MIDI synchronizing. Hold down SHIFT and press MIDI/SYNC (8 on the numeric pad) to display the MIDI/SYNC mode screen.

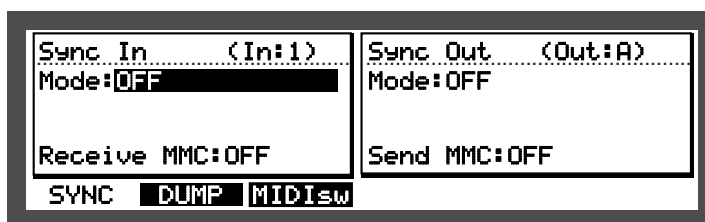

Receiving SMPTE Time Code

Select SMPTE in the Mode: field on the left (when doing so, the In: field settings are ignored).

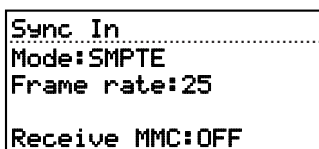

Sending SMPTE Time Code

Select SMPTE in the Mode: field on the right (the settings in the Out: field are only valid for MMC send).

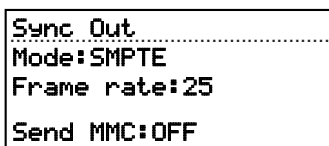

The frame rate settings and start time settings are the same as MTC.

MIDI Sample Dump

Sound data can be transmitted and received between the MPC2000XL and external devices via MIDI using the MIDI Sample Dump Standard Format.

Sample Dump Setting

Connect the MPC2000XL and external device with MIDI cables in the hand shake method (Connect MIDI OUT of MPC2000XL to MIDI IN of the external device, and MIDI IN of MPC2000XL to MIDI OUT of the external device). Hold down SHIFT and press MIDI/SYNC (9 on the numeric pad) to display the MIDI/SYNC mode screen and press DUMP [F2] key.

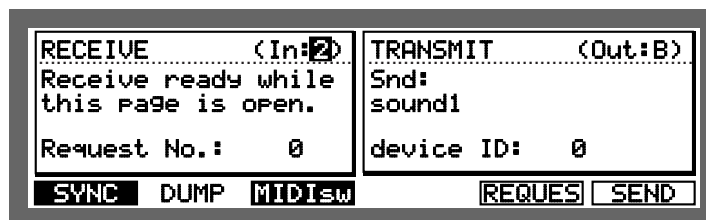

Receiving Sample Data

Selecting the MIDI Input/Output Terminals

Select the MIDI Input and Output terminals used for the connection with the external device in the In# and Out# fields respectively.

Setting the Device ID

Match the device ID number with that of the external device in the Device ID# field of the TRANSMIT screen.

Selecting the Request Number

You can specify which sound to receive from the external device by selecting the sound number in the Request No.# field. Please refer to the instruction manual of the external device for the assignment of sounds and sound numbers.

Note: Not necessary to set if Request is not sent.

Receiving Sample Dump

Sample Dump receive is started either by sending the sample data from the external device, or sending the Sample Dump Request to the external device by pressing REQUES [F5]. While the Sample Dump data is being received, the following message will appear.

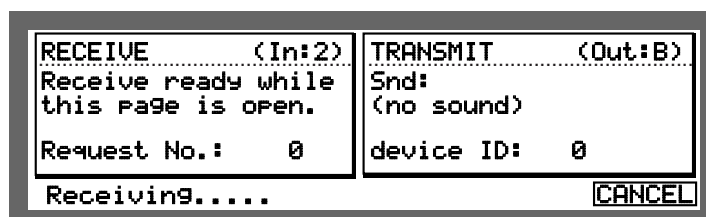

If you want to abort Sample Dump receive, press CANCEL [F6]. When Sample Dump receive is completed, the following window will appear.

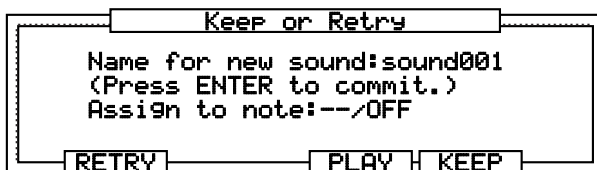

You can play the sound by pressing PLAY [F4]. Name the sample received in the Name for new sound: field, and assign the sample received to a Note Number in the Assign to note: field. Press RETRY [F2] to receive data again, or press KEEP [F5] to keep the sample in memory. The received sound will be named as MIDI 0-n (n being the number of the sound received) automatically.

Sending Sample Data

Selecting the MIDI Input/Output Terminals

Select the MIDI Input and Output terminals used for the connection with the external device at In: and Out: fields respectively.

Sending Sound

Select the sound to be sent in the Snd: Field.

Note: If the selected sound is a stereo sound, the L/R selection field will appear following the name of the sound. Select which side of the sound is to be sent here.

Setting the Device ID

Match the device ID number with that of the external device in the Device ID: field of the TRANSMIT screen.

Commence Sending the Sample Dump

Pressing SEND [F6] will start sending Sample Dump data.

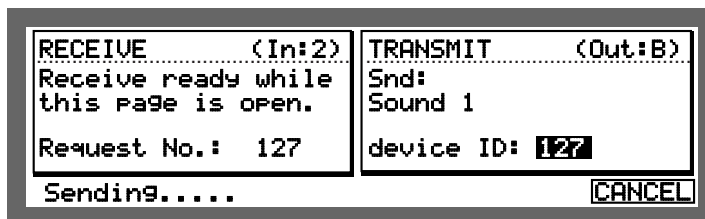

If you want to abort sending Sample Dump data, press CANCEL [F6].

Note: When the Sample Dump Request is received, the sound data of the requested sound number will be sent disregarding the selection in the Snd: field.

MIDI Footswitch Assignment

MIDI Control Change messages sent from the external MIDI devices to the MPC2000XL can control various functions of the MPC2000XL.

Footswitch Setting

MIDI Footswitch Assignment is set from the MIDI/SYNC mode. Hold down SHIFT and press MIDI/SYNC (9 on the numeric pad) to display the MIDI/SYNC mode screen and then press MIDISw [F3].

Switch 1	Switch 2	Switch 3	Switch 4
Ctrl: 10	Ctrl: 26	Ctrl: 69	Ctrl:127
Function: ODUB/PNCH	Function: ODUB+PLAY	Function: F6	Function: PAD 10
SYNC DUMP MIDISw			

Here, you can set the MIDI Control Change message to control each switch in the `Ctrl:` field and its function in the `Function:` field.

Note: Each Function is activated when a data value of 64 or more is received. However, TAP and PAD 01 to 16 will be turned on when the received value is 64 or more, and turned off when it is less.

The assignable functions are as follows.

PLAY STRT	Same function as PLAY START key.
PLAY	Same function as PLAY key.
STOP	Same function as STOP key.
REC+PLAY	Same function as pressing the PLAY key while holding the REC key down.
ODUB+PLAY	Same function as pressing the PLAY key while holding the OVERDUB key down.
REC/PUNCH	Goes into PLAY from STOP mode, goes into REC (Punch-in) from PLAY mode or goes into PLAY (Punch-out) from REC mode.
ODUB/PNCH	Goes into PLAY from STOP mode, goes into OVERDUB (Punch-in) from PLAY mode or goes into PLAY (Punch-out) from OVERDUB mode.
TAP	Same function as TAP TEMPO key.
PAD BANK A to D	Same function as PAD BANK A - D keys.
PAD 1 to 16	Simulates the drum pad being pressed at full velocity.
F1 to F6	Same function as the Function key. The function varies according to the screen displayed at that time.

Note: While recording the sequence, the Control Change messages assigned for this MIDI Footswitch Assignment will not be recorded. Similarly, the recorded Control Change messages in the sequence will be ignored during playback.

The MIDI channel to receive these Control Change messages is set in the MIDI Input Window (select the track type field on the Main Screen - to the right of S# - and press OPEN WINDOW).

OTHER MODE

Set the tempo with the TAP TEMPO key and initialize the data. It is also possible to check the version of the MPC2000XL operating system.

OTHERS Screen

Hold down SHIFT and press OTHER (8 on the numeric pad) to display the OTHER mode screen.

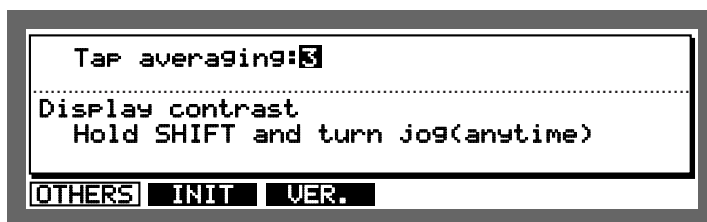

- **Tap averaging:**
Hit TAP TEMPO to set the tempo. The MPC2000XL sets the tempo to the average of the tempo tapped.
Set the number of taps used to calculate the tempo here.
When this is set to a large value, it is possible to get an accurate tempo. However, this does not respond to rapid changes in the tempo.
When this is set to a small value, the function will be able to cope with rapid changes in the tempo, but the inaccuracy of the displayed tempo will increase.

Hold down SHIFT and rotate the DATA wheel to set the contrast of the LCD. It is possible to change this regardless of the displayed mode.

INIT Screen

Hold down SHIFT and press OTHER (8 on the numeric pad) to display the OTHER mode screen and press INIT [F2] to display the INIT screen.



Pressing DO IT [F6] erases the parameter data from the MPC2000XL memory and initializes them to their default parameters.

VER. Screen

Hold down SHIFT and press OTHER (8 on the numeric pad) to display the OTHER mode screen and press VER. [F3] to display the Version screen.

The version of the operating system currently loaded on the MPC2000XL is displayed.

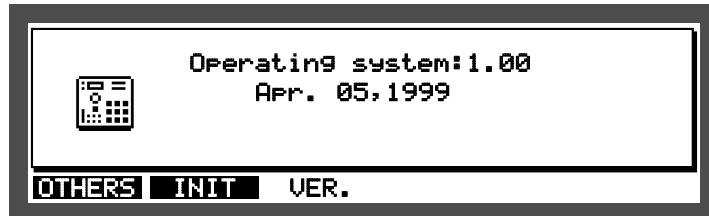



Appendix

Notes on Using SCSI Drives

Connecting an External SCSI Drive

SCSI devices (hard disk, MO drives, etc.) are connected as follows:

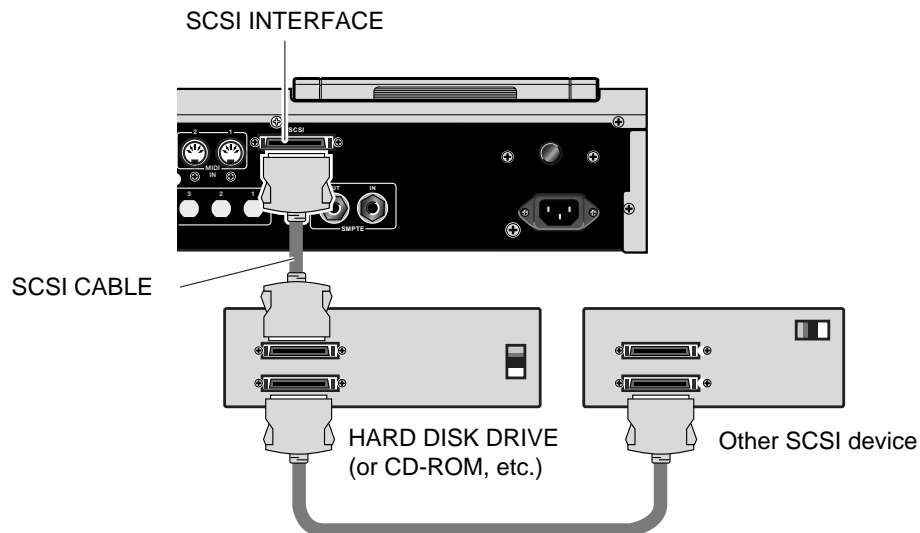

The MPC2000XL uses a 50-pin high-pitch SCSI connector to load or save data to other devices such as hard disks connected by a SCSI cable. By setting the SCSI ID number, it is possible to connect multiple SCSI devices on the same SCSI bus. When multiple SCSI devices are connected to the MPC2000XL, it is possible to select the disk you want to work with using that ID number.

CAUTION: *Although many types of SCSI drives are available, not all can be connected to the MPC2000XL. Please consult the dealer about the types that can be used.*

SCSI Cables

Always use high quality cables. Using cheaper cables may seem an attractive proposition, especially if you have a tight budget but low quality cables can give rise to data errors.

There are two main types of cable that you can buy. One is the 'moulded' type with moulded connectors either end and a round cable. The other type are flat 'ribbon' cables. This type of cable is really intended only for use inside devices.

The SCSI connection requires that every connection is individually grounded. Some moulded cables only have a single ground for all the connections and can be unreliable. They are probably fine when used with a computer for loading small documents such as word processor files, etc., but with the large amounts of sample data used on the MPC2000XL, we have had reports of them causing problems.

The flat ribbon cables, however, have individual grounding for each connection and so are generally more reliable but, because they are intended for use inside devices (where they are separately screened), they sometimes have insufficient screening which may cause data noises to appear in your audio signal path when any disk activity is going on, especially if your audio connections run parallel with the SCSI cable. However, if this is not a problem for you (and in a studio it may not be), these cables are usually very good and usually perform much more reliably. In a live situation, however, they are probably not ideal.

SCSI ID

Make sure the SCSI ID number of the device connected to a SCSI bus is unique. For example, the ID of the MPC2000XL is 6 and the ID of the other devices connected must be set to any number other than 6. To set the ID of external SCSI devices, check the manual of the device.

Termination

A chain of SCSI devices must be terminated at either end and terminating resistors are fitted to most SCSI devices when you buy them. The MPC2000XL's SCSI interface is terminated. It is most likely that the MPC2000XL will be at one end of the chain and so must be left terminated. Any disks in between the MPC2000XL and the last SCSI device in the chain must be un-terminated (this can be done by physically removing the resistors or sometimes via a DIP switch on the back of the unit - please check the unit's documentation). The last device in the chain must be terminated.

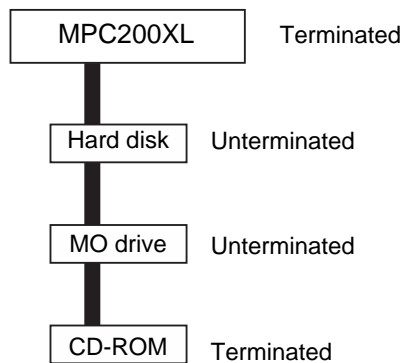

Incorrect termination may give rise to data errors and possibly corrupted data so please ensure it is done correctly. If you have any doubts, please contact your dealer who will be able to help.

Cable Length

The SCSI specification states that the total length of the SCSI chain must not exceed 6 metres. "Total length" means the length of the whole chain between the first and the last device and not the length of the cable between each of devices. SCSI chains that are longer than the specified length may cause data errors and possibly corruption of data.

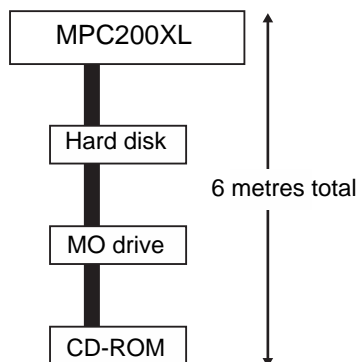

Installing the Options—To Service Technicians

CAUTION: .

These servicing instructions are for use by qualified personnel only. To reduce the risk of electric shock, do not perform any servicing other than that contained in the Operating instructions unless you are qualified to do so. Refer all servicing to qualified service personnel.

The MPC2000XL can accommodate several options. These are the IB-M208P 8 individual outputs digital Input/Output, the IC-M2TC SMPTE I/O, the EB16 multi-effects processor and memory expansion.

Important Note:

Consult your AKAI professional dealer on installation of any options (including memory) to the MPC2000XL. Self-servicing may cause malfunction of components or the instrument itself. AKAI professional does not guarantee against the unit's malfunction, damage or any loss caused by self-servicing or improper operation.

Locations of the MPC2000XL Option Boards

SMPTE IC chip (IC-M2TC), Effect Board (EB16), Flash ROM (FMX008M), 8 Individual Output with digital I/O (IB-M208P), Simm Memory Board (S3SM16).

Disconnect the power cable from the MPC2000XL before doing any work on the MPC2000XL!

Undo the screws on the bottom plate and remove it.

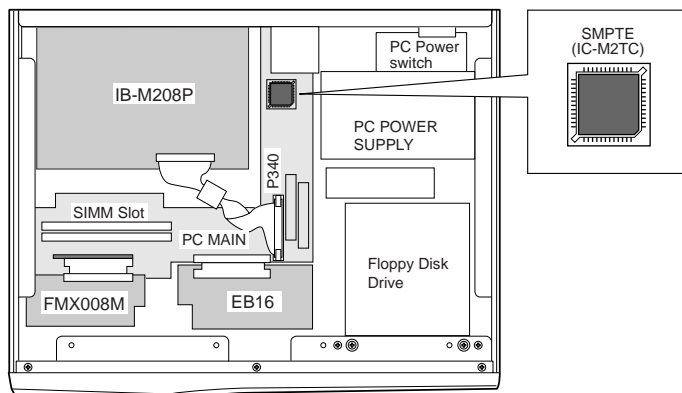
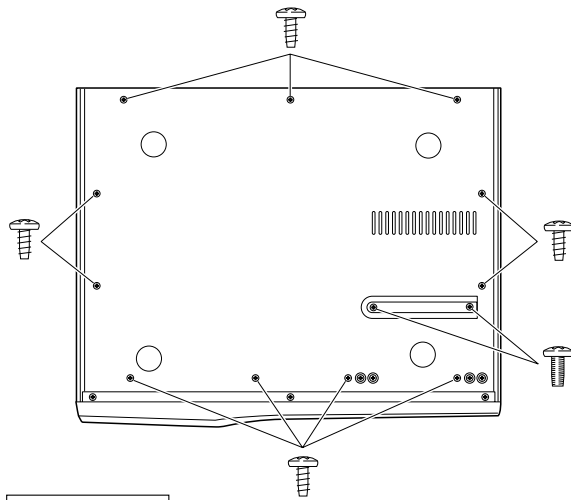

IC-M2TC

You should take care that the IC is in the correct position when installing. Insert the IC according to the direction of the socket.

EB16

Connect this to the J330 connector on the PC MAIN board and secure it with the provided screw.

FMX008M

Connect to the provided relay board and secure it with the provided screw.

(Note: Installation without using the RELAY board may cause damage to the FMX008M board or MPC2000XL's PC MAIN board.)

IB-M208P

Remove the cover on the REAR PANEL and install as shown in the illustration. Next, secure it with the provided screws and connect the cable to the P340 connector on the PC MAIN board.

(Note: Make sure that the IC522 and Ferrite Core (attached to the connecting cable) components do not touch the bottom plate.)

Installing Memory Expansion

The MPC2000XL's internal memory can be expanded to 32Mbytes using SIMMs. The MPC2000XL comes with 2Meg of memory 'hardwired' and there are two slots in which you can install SIMMs chips. The SIMMs board is inserted at a slight angle and then pushed back where it clips into place. Some SIMMs boards have the memory chips mounted on both sides sometimes. However, the boards can only be inserted one way so you shouldn't have any problems. Be careful not to force them into place otherwise they may snap.

SIMMs operate at different speeds. SIMMs that operate at a speed of 70nS (nanoseconds) or faster are recommended.

SIMMs also come in various sizes. Please note the following memory configurations that are possible in the MPC2000XL.

Internal	SIMMs Slot 1	SIMMs Slot 2	TOTAL
2M	None	None	2M
2M	16M	None	18M
2M	16M	16M	32M*
2M	32M	–	32M*

* When 32M SIMMs are installed, the 2Meg on the MAIN board is ignored.

Note: Memory chips are sensitive to static electricity. Please observe the following safety precautions:

- Unplug the MPC2000XL before installing the board(s).
- The SIMMs may come with a special wrist strap to discharge static electricity. We suggest you attach the strap to the MPC2000XL's case. If a wrist strap or any other such accessory is not supplied, try discharging any static by touching an earthed metal object before handling the boards.
- Always handle the memory board by its edges - avoid touching the components on the board.
- To minimise static electricity, avoid carpeted areas and low humidity areas.

Technical Specifications

General

- Display 248 x 60 dot graphic LCD
- Disk drive 3.5 inch 2HD/2DD
- Dimensions 405(W) x 106(H) x 331(D) mm
- Weight 5.5 kg
- Power requirements 100-240 VAC, 50/60Hz, 23W (13W without option)
- Memory expansion slot 2 / 72-pin SIMM (70ns)

Sound Generator

- Sampling rate 44.1kHz (frequency response: 20Hz-20kHz)
- Sampling capacity 2MB standard (21.9 seconds mono or 10.9 seconds stereo), expandable to 32MB.
- Data format 16-bit linear
- Dynamic filtering 12dB/Octave dynamic resonant lowpass filter per voice
- Maximum sounds in memory 256
- Number of sound programs 24
- Sound assignments per program .. 64
- Simultaneous voices 32

Sequencer

- Maximum events 300,000 notes (maximum 50,000 notes per sequence) (notes equivalent)
- Resolution 96 parts per 1/4-note (ppq)
- Sequences 99
- Tracks per sequence 64
- MIDI output channels 32 (16 channels x 2 output ports)
- Song mode 20 songs, 250 steps per song
- Drum pads 16 (velocity and pressure sensitive)
- Drum pad banks 4
- Sync modes MIDI clock and SMPTE (optional). SMPTE frame rates supported are 24, 25, 29.97 drop and 30.

Rear Panel Inputs/Outputs

- Record input (both L and R) 1/4-inch stereo phone x 2, balanced -40dBu, input Imp. 39k Ω ; Max. input level +10dBu
- Digital sampling input RCA-pin x 1, S/PDIF (optional)
- Digital master output RCA-pin x 1, S/PDIF (optional)
- Stereo output 1/4-inch phone x 2, unbalanced +11dBu, output Imp. 100 Ω ; Max. output level +17dBu
- 8 individual outputs 1/4-inch phone x 8, unbalanced +11dBu, output Imp. 100 Ω (optional); Max. output level +17dBu
- Headphone output 1/4-inch stereo phone x 1, 200mW/32 Ω
- MIDI inputs 5-pin DIN x 2
- MIDI outputs 5-pin DIN x 2 (independent)
- SCSI port 50-pin high-pitch SCSI connector x 1

Options

- EB16 Multi-effect processor board
- FMX008M 8Mb Flash ROM board
- IB-M208P 8 individual output and digital In/Out board
- IC-M2TC SMPTE IC chip
- S3SM16 16 Mb SIMM board

Standard accessory

- Power cable 1
- CD ROM disc 1 / Sound library disc
- Operator's manual 1

$$0dBu = 0.775V_{rms}$$

The MIDI Implementation Charts

MIDI Implementation Chart

Date: May, 1999

Model: MPC2000XL (sound generator section)

Version: V1.0

Function	****	Transmitted	Recognized	Remarks
Basic Channel	Default Changed	16 1 - 16	16 1 - 16	
Mode	Default Messages Altered	3 X X	3 X X	
Note Number	True Voice	35 - 98 35 - 98	35 - 98 35 - 98	
Velocity	Note ON Note OFF	O O (Always = 64)	O X	
After Touch	Key's Ch's	X X	X O	Used in Note Repeat feature
Pitch Bender		X	X	
Control Change	7	X	O	Can be assigned to Note Variation Slider
Prog Change (True #)		X	0 - 127	
System Exclusive		O	O	Sample Dump only
System Common	: Song Position : Song Select : Tune	X X X	X X X	
System Real Time	: Clock : Commands	X X	X X	
Aux Messages	: Local ON/OFF : All Notes Off : Active Sense : Reset	X X X X	X O X X	
Note:				

Mode 1 : OMNI ON, POLY
Mode 3 : OMNI OFF, POLY

Mode 2 : OMNI ON, MONO
Mode 4 : OMNI OFF, MONO

O : YES
X : NO

MIDI Implementation Chart

Date: May, 1999

Model: MPC2000XL (sequencer section)

Version: 1.0

Function	****	Transmitted	Recognized	Remarks
Basic Channel	Default Changed	1 - 16 1 - 16	1 - 16 1 - 16	
Mode	Default Messages Altered	3 X X	1 X X	
Note Number	True Voice	0 - 127 0 - 127	0 - 127 0 - 127	
Velocity	Note ON Note OFF	O O	O O	
After Touch	Key's Ch's	O O	O O	
Pitch Bender		O	O	
Control Change	0 1 127	O	O	See note below
Prog Change	True#	O 0 - 127	O 0 - 127	
System Exclusive		O	O	ID: 45h Sequence recording only
System Common	: Song Position : Song Select : Tune	O X X	O X X	
System Real Time	: Clock : Commands	O O	O O	
Aux Messages	: Local ON/OFF : All Notes Off : Active Sense : Reset	X O X X	X X X X	
<p>Note : If the Convert Sustain Pedal To Duration field (accessed from the Main Screen: select the Track Type field and press OPEN WINDOW) is set to ON, then incoming controller 64 messages (sustain pedal) will not be recorded into sequences. Instead, any notes that are currently pressed when a Sustain On message is received are internally held on, even after they are released, until a Sustain Off message is received. The result is that the individual durations of notes are lengthened. This is explained further in the "Receiving MIDI Data" section earlier in the manual.</p>				

Mode 1 : OMNI ON, POLY
Mode 3 : OMNI OFF, POLY

Mode 2 : OMNI ON, MONO
Mode 4 : OMNI OFF, MONO

O : YES
X : NO



AKAI professional M.I. Corp.